



MEDALPOWER

6KVA, 10KVA

Online UPS

MP-OU6K#12B9T
MP-OU10K#16B9T



www.medal-power.com



Please follow all warnings and operating instructions described in this manual. Please store this manual in a proper place so that you can read the following precautions before installation. Before operating this product, please read all safety matters and operating instructions carefully.

Contents

1. Notes on Safety and Battery Compatibility	1
1-1. Transport and Storage.....	1
1-2. Preparation.....	1
1-3. Installation.....	1
1-4. Connection Considerations.....	2
1-5. Operation.....	3
1-6. Standard.....	3
2. Installation and Setting	4
2-1. Unpacking and inspection.....	4
2-2. Backboard View.....	5
2-3. Stand-alone Installation.....	6
2-4. Software Installation.....	8
3. Using Operation	9
3-1. Routine Turn-on and Turn-off.....	9
3-2. Panels.....	10
4. Setting	12
4-1. Output Voltage.....	12
4-2. Other Function Setting.....	13
5. Troubleshooting Code	16
5-1. Troubleshooting Instruction.....	16
5-2. Warning Instruction.....	17
6. Technical Parameters	18
7. Storage and Maintenance	19
7-1. Storage.....	19
7-2. Maintenance.....	19

1. Security and electromagnetic compatibility (EMC) related considerations

Please read the user manual and safety instructions before installing and using this product!

1-1. Transport and storage



When it is necessary to move this UPS system, it is important to pack the original packaging materials first to prevent and mitigate accidental collisions.



This UPS product must be stored in a dry and well ventilated location.

1-2. Preparation



This UPS system may have condensation when it is fed directly from a cold environment to a warm environment such as indoors. At this point, it is important to wait until it is completely dry before installing. To do this, place at least 2 hours after moving to the installation site to allow UPS to adapt to the environment before installing.



This UPS system must not be installed in an environment full of water or moisture nearby.



The UPS system must not be installed in places where there is direct sunlight or nearby heaters.



Never block or cover the ventilation holes on the UPS cabinet.

1-3. Installation



Never connect equipment that can cause the UPS to overload (such as high-power electromechanical equipment) to the output of the UPS.



Power cables such as power cords should be routed to avoid places where they can be trampled or tripped.



Do not block or obscure vents on this UPS housing. This UPS installation must be well ventilated and confirm that there is sufficient ventilation space around the UPS host.



The UPS is equipped with a grounding terminal, which is used to connect the external UPS battery box to form an equipotential grounding after the system is installed.



This UPS can only be installed by professional maintenance personnel.



The building system should provide short-circuit protection.



The building system should be equipped with a set of total emergency switches to power off UPS to all loads in a timely manner when needed.



UPS should be grounded before it is wired to a building system.



Installation and wiring must comply with local power laws and regulations.

1-4. Connection Precautions

• There is no Backfeed protection device installed inside this machine, please add an isolation device before using this machine, which must be able to carry the input current of this continuously charged system.

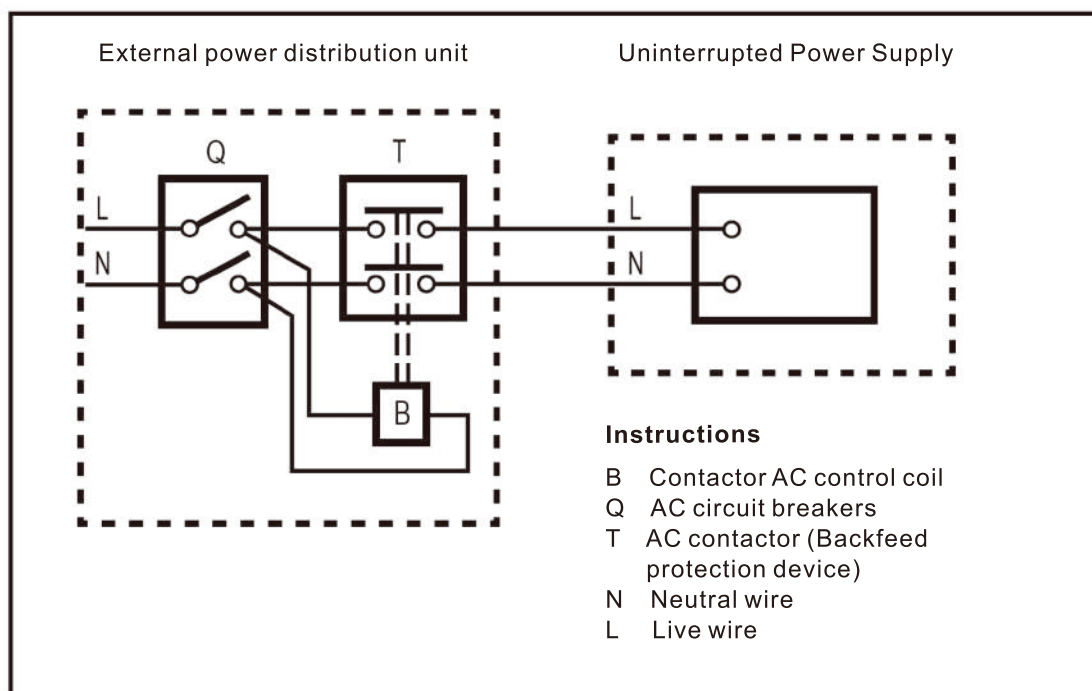

- The UPS must be grounded.
- The input power end of the UPS must be single-phase and grounded.
- The UPS is not recommended for life-sustaining applications, as it is possible to cause failure of these instruments in the event of an error in this equipment. DO NOT use the equipment in an environment where flammable gases are present with air, oxygen or nitrous oxide.
- Make sure that the output ground terminals of the UPS are indeed connected to the ground wire.
- The UPS is connected to a DC power supply, the battery, so even if the UPS is not connected to mains power, the output terminal blocks may still be charged.





Before repairing the circuit wiring

- Separate the Uninterrupted Power Supply (UPS) first.
- Hazardous voltage tests are then performed between terminals, including protective ground terminals.



Danger of backfeeding

1-5 Operation

-  Do not disconnect the UPS wiring cable or the building system cable, otherwise the protective ground of the UPS system and the connected load will fail.
-  UPS is characterized by its own internal battery, and all of its output terminals may be charged even if UPS is not connected to any building wiring system.
-  To completely disconnect the UPS system, press the OFF button before disconnecting the mains power.
-  Prevent any liquid or other foreign material from entering the UPS system.
-  The operation of this UPS system can be carried out by inexperienced persons.

1-6. Standard

* Security.	
IEC/EN 62040-1	
* EMI	
Transmit radiation.....:IEC/EN 62040-2	Category C3
Electromagnetic radiation.....:IEC/EN 62040-2	Category C3
* EMS	
ESD.....:IEC/EN 61000-4-2	Level 4
RS.....:IEC/EN 61000-4-3	Level 3
EFT.....:IEC/EN 61000-4-4	Level 4
SURGE.....:IEC/EN 61000-4-5	Level 4
CS.....:IEC/EN 61000-4-6	Level 3
Low-frequency magnetic field:IEC/EN 61000-4-8	Level 4
Low-frequency signal.....:IEC/EN 61000-2-2	
Warning: This product is non-civilian commercial and industrial and may require additional precautions to prevent interference.	

2. Installation and settings

This online UPS is divided into two types: standard and long-run. Here's a comparison table:

Model	Type	Model	Type
6K	Standard	6KS	Long-run
10K	Standard	10KS	Long-run

2-1. Unpacking and inspection

Please open the package and check that the following items are complete. The packaging contains the following items:

- A UPS
- An instruction manual
- A piece of Monitoring software installation CD (optional)
- A RS-232 connecting cable (optional)
- A battery cable (optional)

Note: Before installation, please review the packaging contents to confirm that there are no suspected damages or evident damages. Do not use this product in the event of any breakage or missing parts, but should immediately notify the shipper and your dealer. Please put away the original packaging materials for future use.

2 - 2 Back View

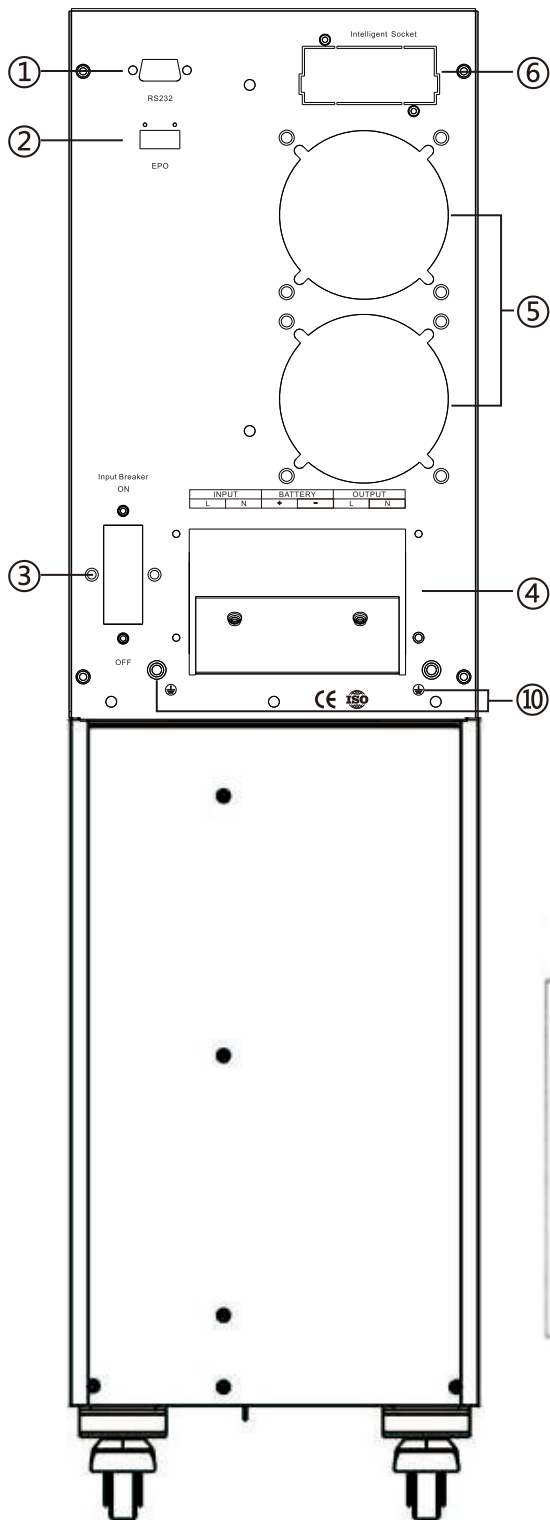

Figure 1: 6K / 10K back panel

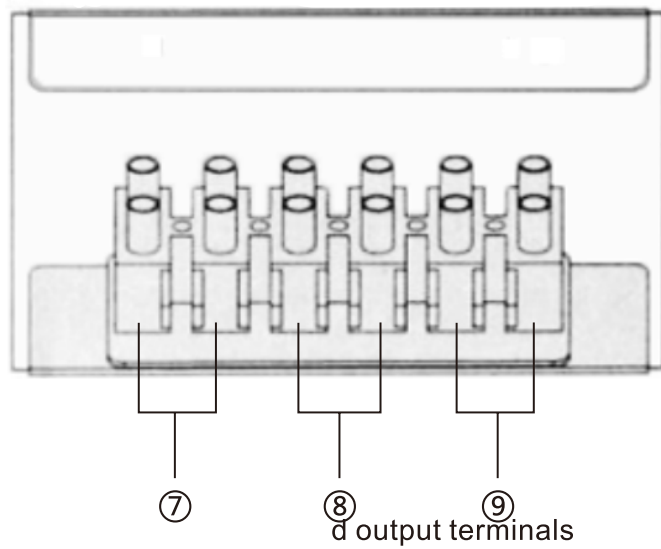

Figure 2: 6K / 10K input and output terminals

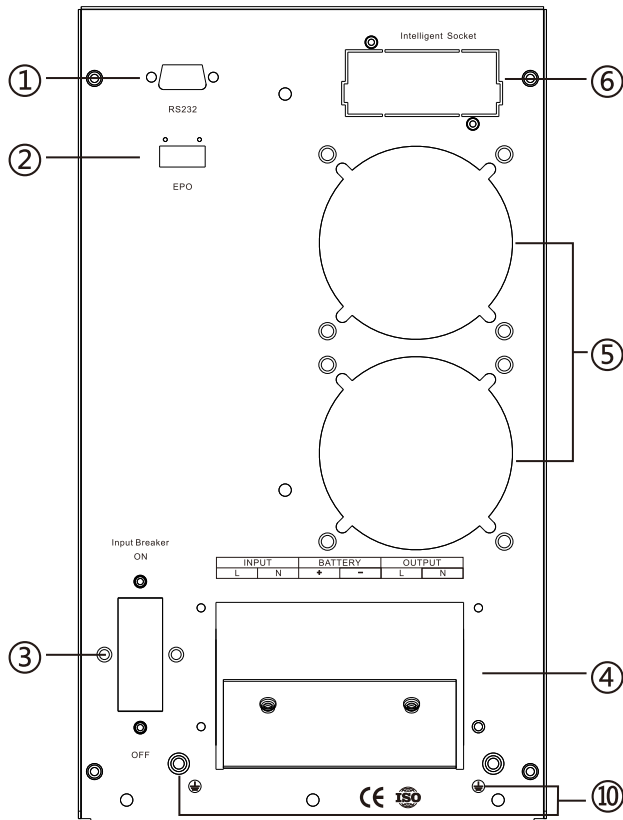

Figure 3: 6KS / 10KS back panel

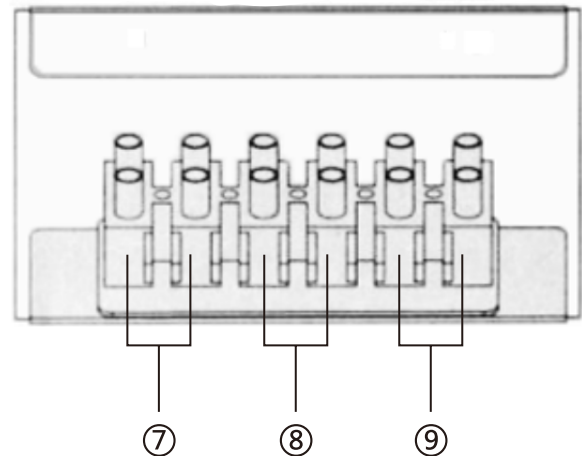

Figure 4: 6KS / 10KS input and output terminals

- 1.RS-232 communication port
- 2.Emergency power off function connector (EPO connector) (optional)
- 3.Input power circuit breaker
- 4.Output / input terminal (please refer to Figure 2.4 for details)

- 5.Fan
- 6.Smart slot
- 7.Mains input terminals
- 8.Battery input terminals
- 9.Output terminals
- 10.Grounded

2 - 3. Stand-alone installation

Installation and wiring must comply with local electrician regulations, and professional electricians should perform the following instructions:

1) Confirm that the building power distribution lines and circuit breakers are sufficient to support the UPS capacity to avoid electric shock or fire accidents. Please note that DO NOT use a wall socket as a UPS input power source (its rated current is less than the maximum input current of this UPS), otherwise the socket may be burned.

2) Before installation, please turn off the indoor main power switch.

3) All load equipment must be powered off before connecting to the UPS system.

4) Prepare the wire according to the following comparison table.

Model	Wiring specifications (AWG)			
	Mains input	Mains output	Battery input	Earth wire
6K	10	12		12
6KS	10	12	12	12
10K	8	8		8
10KS	8	8	8	8

Note 1: It is recommended to use the wire of the recommended specification or higher specification in the above table to take into account safety and efficiency.

Note 2: The color of the wire must comply with local electrical regulations.

5) Remove the terminal block cover on the back panel of the UPS. Then, follow the terminal block diagram below to wire. (When wiring, please connect the earth wire first. When removing the wiring, the earth wire should be the last to remove!)

Input		Battery		Output	
L	N	+	-	L	N

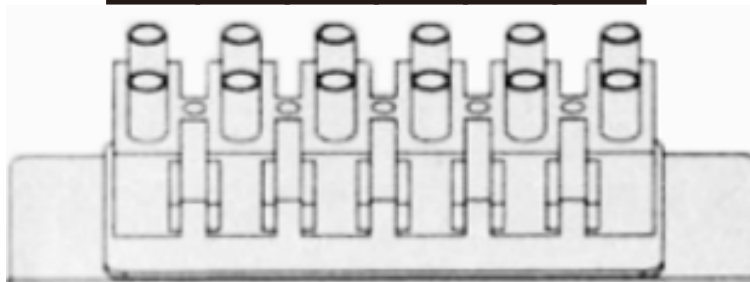

Terminal block diagram

Note 1: Make sure that all wires on the terminals are locked and fixed.

Note 2: Please install an output circuit breaker between the output terminal and the load device, and make sure that the circuit breaker has a leakage protection function.

6) Put the terminal block cover back in place.

⚠ Warning: (For standard models ONLY)

- Before installation, please make sure that the UPS has not been turned on. The UPS cannot be turned on before the installation is completed.

- DO NOT try to modify the standard model to the long-run model. In particular, DO NOT connect standard built-in batteries to external batteries. This is because the battery specifications and voltage may be different, and once connected, there will be a risk of electric shock or fire!



Warning: (For long-run models ONLY)

- Please confirm that there is a DC circuit breaker or other protective equipment with the same function between the UPS and the external battery. If not, please be very careful when installing external batteries. When there is a circuit breaker, please disconnect the battery circuit breaker before installation.



Warning:

- In the standard battery box, a DC circuit breaker is provided to disconnect the battery box and the UPS. However, for other external batteries, please confirm whether there is a DC circuit breaker or other protective equipment with the same function between the UPS and the external battery. If not, please be extra careful when installing external batteries. When there is a circuit breaker, please disconnect the battery circuit breaker before installation.

- Please confirm the battery voltage number marked on the machine first. If you want to adjust the number of battery connections, be sure to adjust the battery voltage setting at the same time. If the number of batteries is not the same as the adjustment setting, it may cause the machine to be damaged. Confirm that the voltage setting of the battery box is correct.

- Please distinguish the positive and negative signs on the external battery terminal block to correctly connect the positive and negative poles of the battery; otherwise, connecting the positive and negative poles incorrectly may cause damage to the UPS that cannot be repaired.

- Please confirm whether the wiring of the ground wire is correct. In particular, it is necessary to check in detail and confirm whether the current specification, color, position, wiring and conductivity reliability of the wiring meet the requirements.

- Please confirm that the wiring of the mains input and output are correct. In particular, it is necessary to check in detail and confirm whether the current specification, color, position, wiring and conductivity reliability of the wiring meet the requirements. Please check and make sure that the live wire and the neutral wire are correctly connected, and there is no reverse or short connection.

2 - 4. Software Installation

In order to provide the most complete computer protection, please install UPS monitoring software.

3. Use operation

3.1 Daily turn on and off

Please refer to this manual for daily operation of turning on, turning off the machine.

3.1.1 Steps to start up

When the required battery or utility power is connected, the start up operation can be carried out.

➤ Mains power on

When the normal mains power is connected and the LCD panel displays the standby mode or the bypass mode, press the power-on buttons (← + ▼) for more than 0.1 second to start the machine, and the LED light will turn on and turn off in turn, and wait a bit, the panel displays the mains mode to indicate that the boot is completed and enters the mains mode.

➤ Battery boot

Insert a normal battery, press the function setting / confirmation buttons (←) for 0.5 seconds or more, the display will light up, the panel will display the standby mode, and the UPS will establish the working power supply. At this time, press the power-on button (← + ▼) for more than 0.1 second to start the machine, and the LED light will turn on and off in turn. After a period of time, the panel displays the battery mode to indicate the power-on is completed and enters the battery mode.

3.1.2 Shutdown steps

When the mains / battery / battery self-check voltage ECO mode is working, press the power off buttons (▼ + ▲) for more than 0.1 second to perform shutdown. After the shutdown operation, if the bypass is normal, the panel displays enter the bypass mode; if the bypass is abnormal, the panel displays the standby mode to enter the standby mode and cut off the output. When shutting down in the bypass mode, it will enter the standby mode and cut off the output.

3.1.3 Manual self-check operation

When the UPS is working in the city voltage ECO mode and the battery voltage is greater than the low-voltage alarm point, press the self-check and mute buttons (← + ▲) for more than 1 second and wait for 10 seconds. The LED lights will turn on and turn off in turn, and the panel displays Battery self-check mode, test whether the battery is normal, automatically exit after completing the self-check, and the LED and LCD return to the state before the self-check.

3.1.4 Muting operation

When the UPS is working in battery / battery self-check / failure mode, press the self-check / mute buttons (← + ▲) for more than 1 second, and the buzzer icon will be displayed in the graphic display area of the panel and the alarm sound will be eliminated. Then press the self-check / mute buttons for more than 1 second, the alarm sound will be restored and the buzzer icon in the graphic display area of the panel will disappear.

When the UPS is in any mode, you can set Mute ON or OFF through the background software to mute / unmute the UPS.

3.1.5 Operation in alarm state

When the UPS has an alarm sound and the LED fault light flashes, it means that the UPS is working in an alarm state. You can check the cause of the alarm based on the alarm information or contact the supplier.

3.1.6 Operation in failure mode

When the UPS buzzer keeps beeping and the LED fault light is on for a long time, it means that the UPS is working in fault mode. You can contact the supplier or maintenance personnel to provide fault alarm related information and assist in troubleshooting.

3.2. Panels

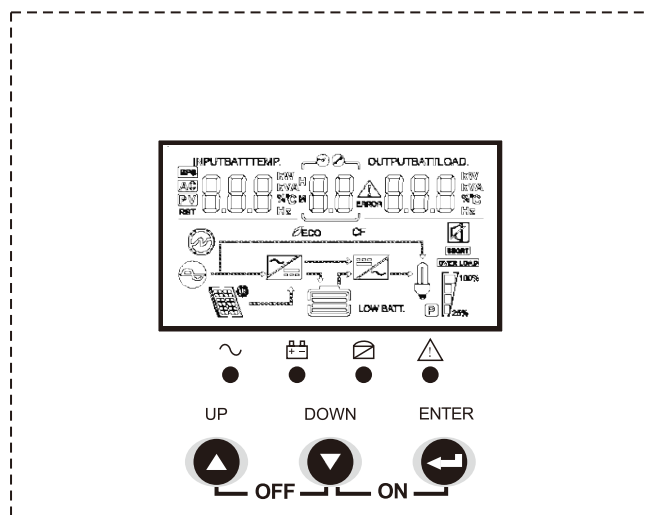

3.2.1 Descriptions of buttons

Buttons	Descriptions
Power on buttons (← + ▼)	Power on: Press the power on buttons for more than 0.1 seconds to boot.
Power off buttons (▼ + ▲)	Power off: Press the power off buttons for more than 0.1 seconds to cut down the power.
Self-check / mute buttons (← + ▲)	Self-check: Press the self-check buttons for more than 1 second in the mains mode to test whether the battery is normal. Mute: Press the mute buttons for more than 1 second in the battery failure/self-check mode to eliminate the alarm.
Function setting /confirmation buttons (← + ▼)	Function setting: Press the function setting button on the display page for more than 2 seconds to enter the function setting page. After confirming the set option, press the function setting button again for more than 2 seconds to return to the main page. Confirmation: On the function setting page, press the confirmation button for 0.1 second to 2 seconds to confirm the set options.



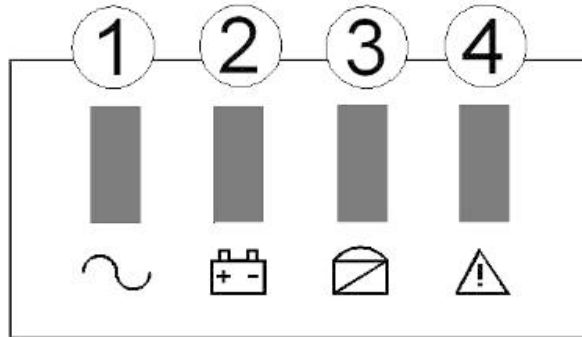



Page turning / inquiry button (▼ , ▲)	<p>Page turning: Press the(▼)or (▲)button on any page for more than 0.1 seconds to turn left or right.</p> <p>Inquiry mode: Press the (▲) button for more than 2 seconds on the display page to enter the inquiry mode, and the content of each page is displayed in a loop. The content of each page is displayed for 2 seconds. Press the (▼) button again for more than 2 seconds to exit the inquiry mode.</p>
---	--



Indicators	Name	Description
	INV (Green)	<p>On: UPS is working in inverter-on mode (such as mains mode, battery mode, battery self-check mode, ECO mode)</p> <p>Off: UPS is working in non-inverter mode and the battery light (yellow)</p>
	Battery (Yellow)	<p>On: UPS is working in battery/battery self-check mode</p> <p>Off: UPS is working in non-battery mode and non-battery self-check mode</p> <p>Flashing: Battery low voltage alarm stack bypass light (yellow)</p>
	Bypass (Yellow)	<p>On: UPS is working in bypass mode or ECO mode.</p> <p>Off: UPS is working in non-bypass mode and non-ECO mode.</p> <p>Flashing: UPS is working in standby mode, frequency conversion is not turned on and bypass is abnormal.</p>
	Warning (Red)	<p>On: failure</p> <p>Off: normal</p> <p>Flashing: alarm</p>

4.Settings

➤ The UPS function setting operation is performed in the standby/bypass mode. The specific operations for entering and exiting the function setting page and function setting are as follows:

- Press the function setting button  for more than 2 seconds to enter the function setting page, press the button  or  for 0.1 second to 2 seconds to select the function. After turning the page to the desired function setting page, the corresponding function word flashes.
- Press the confirmation button  for 0.1 second to 2 seconds to enter the setting page of the selected function. At this time, the selected function will be lit, and the value will flash on the right of the selected function. Press the button  or  for 0.1 second to 2 seconds to select the value of the required function parameter.
- After turning the page to the function parameter you need to select, press the confirmation button  for 0.1 second to 2 seconds, the function setting is completed, at this time the function parameter value is long on and no longer flashes.

Press the function setting button  for more than 2 seconds to exit the function setting page and return to the main page (you can also do no any operations, and then automatically jump back to the main page after waiting up to 30 seconds).

4.1 Output voltage (OPU)

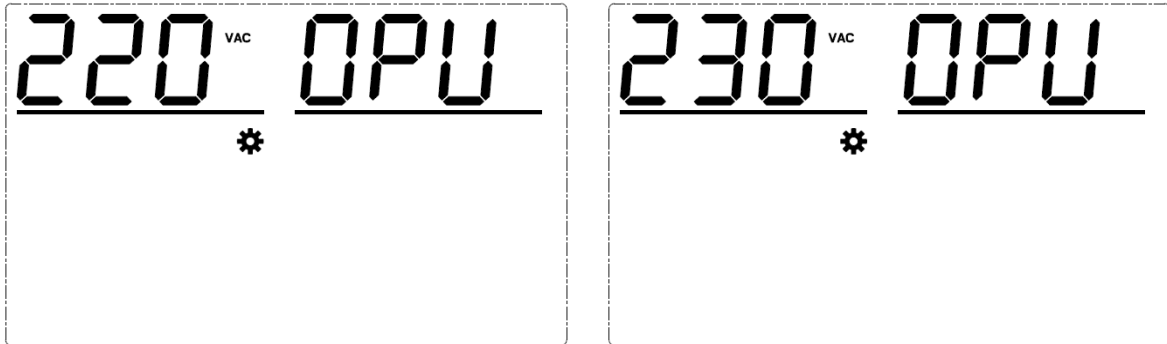







Figure 5 - 1 shows the setting page of the output voltage

- Press the function setting button  for more than 2 seconds to enter the function setting page, press the button  or  for 0.1 second to 2 seconds, to select the function. Then turn the page to the output voltage OPU setting page, the word OPU flashes.
- Press the confirmation button  for 0.1 second to 2 seconds to enter the output voltage OPU setting page, at this time the word OPU is on and the value flashes to the right of the word OPU. Press the button  or  for 0.1 second to 2 seconds to select different output voltage values. The available voltage values are 208V, 220V, 230V, 240V. By default, the output voltage is 220V, and the settings made are saved in real time.

●After turning the page to the desired output voltage value, press the confirmation button \leftarrow for 0.1 second to 2 seconds, the output voltage OPU setting is completed. At this time, the value on the right of OPU is long on and no longer flashes.

Press the function setting button \leftarrow for more than 2 seconds to exit the function setting page and return to the main page (you can also do no any operations, and automatically jump back to the main page after waiting up to 20 seconds).

Note:

- When the output voltage is set to 208V, the output needs to drop to 90%.

4.2 Other feature settings

4.2.1 Expert Mode (EP)

If Expert mode is set to ON, it will go back to the function settings page again, where options such as battery number (PCS), Emergency Power Off (EPO) and charging current are available, and when Expert mode is set to OFF, the feature settings page has only a few general feature options.

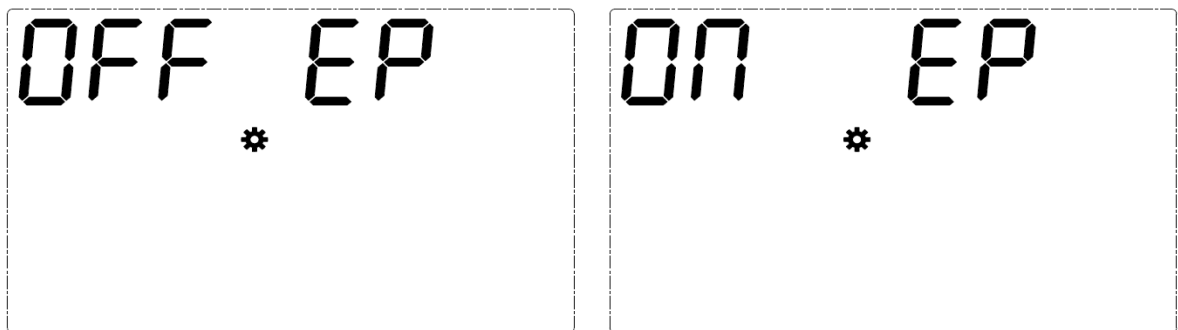

Figure 5-2 Expert mode settings page

Note:

Expert mode is OFF by default. After setting it to ON, the EP will return to OFF after power-on.

4.2.2 Battery Low Voltage Shutdown Point (EOd)

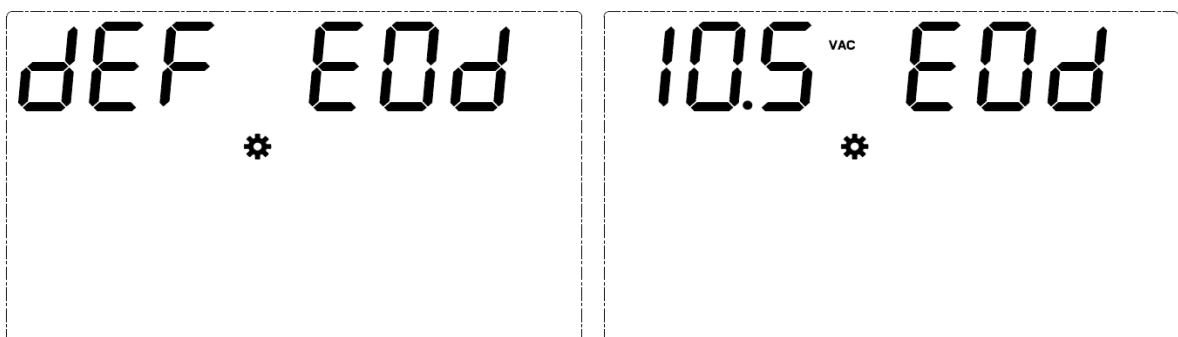

Figure 5-3 Battery low voltage shutdown point settings page

Description:

The battery low voltage shutdown points available are dEF, 9.8V, 9.9V, 10V, 10.2V, 10.5V. By default, the battery low voltage shutdown point is dEF (battery low voltage shutdown point varies with load, 10.5V@ load <25%, 10.2V@25% < load <50%, 10V@ load >50%).

4.2.3 Economic Mode of Operation (ECO)

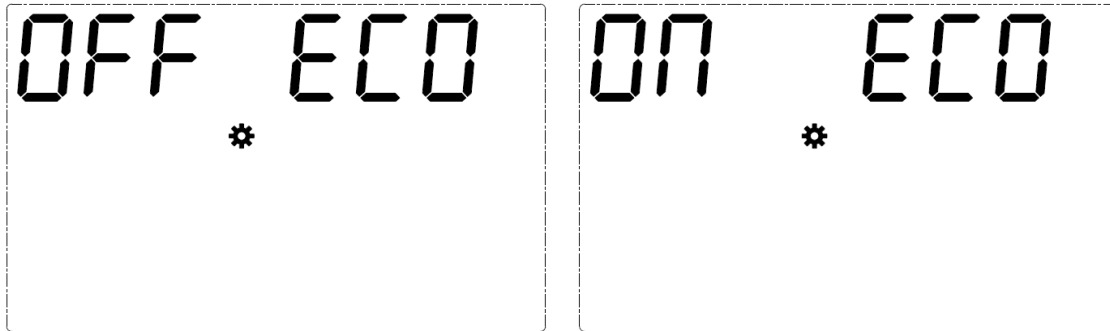

Figure 5-4 Economic Mode Settings page

Instructions:

Economic mode(ECO) is turned off by default, with the option to turn it on to improve the efficiency of the system.

Precautions:

The UPS type of PF < 1 , the ECO mode is turned off by default and cannot be set.

4.2.4 Emergency Power Off (EPO)

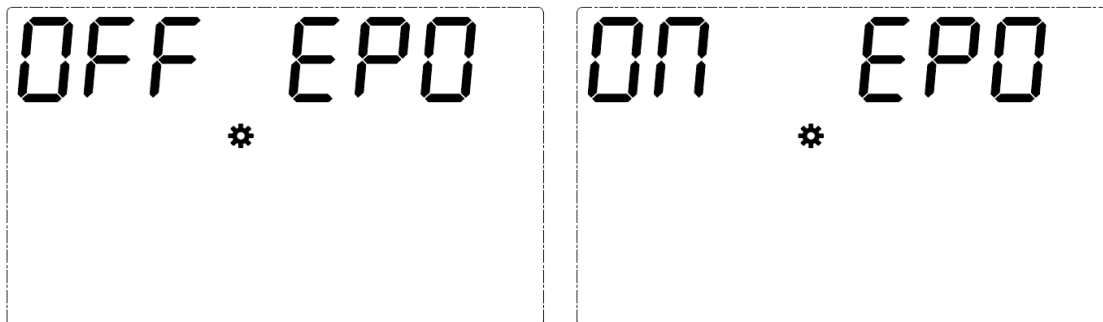

Figure 5-5 Emergency Power Off Settings page

Instructions:

When EP is set to ON, the EPO option appears on the feature settings page to set up the mode of Emergency Power Off . The Emergency Power Off function pulls the EPO terminal active (OFF) by default, with the option of plugging in the EPO terminal valid (ON) instead.

Precautions:

The Emergency Power Off is output after the EPO action.

4.2.5 Number of batteries

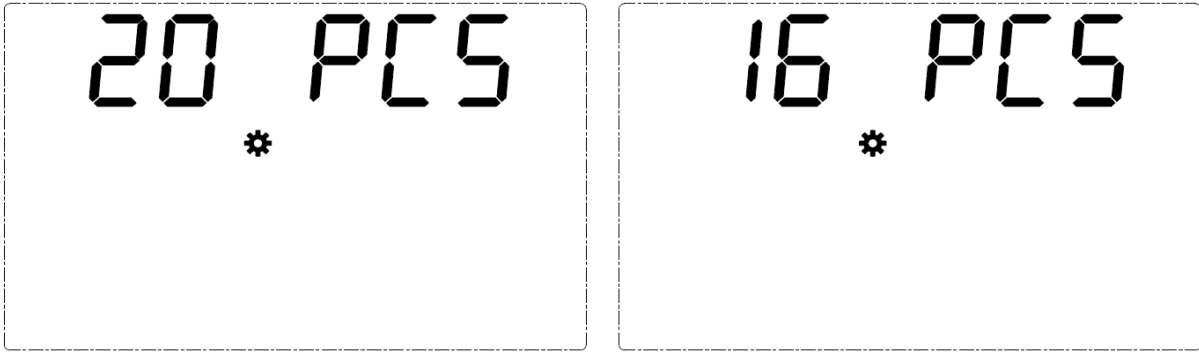

Figure 5-6 Setting of the number of batteries

Instructions :

When the EP is set to ON, the function settings page appears PCS options, go to the password page, enter the password (default password is 135), you can set the number of battery. The battery number system defaults to 16 pcs and can be set to 16, 18 or 20 pcs.

4.2.6 Charging Current (CHG)

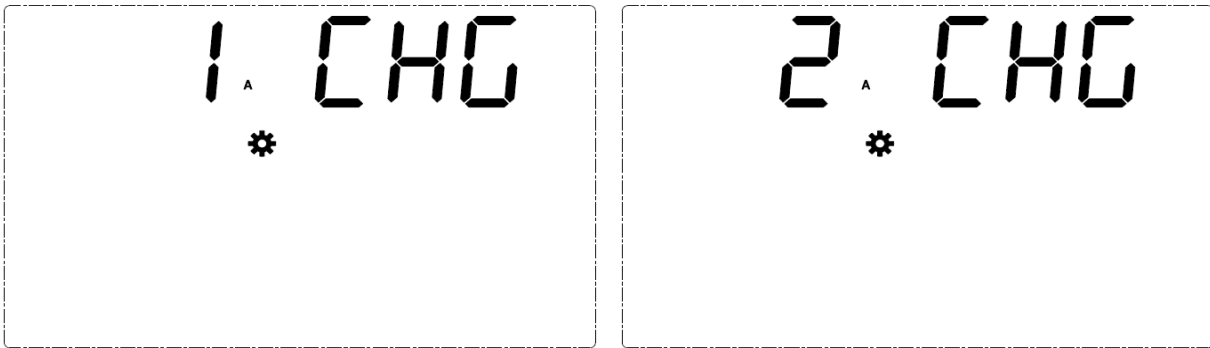

Figure 5-7 setting of the number of batteries

Instructions :

When the EP is set to ON, CHG option shows on the function settings page, charging current can be set, 1-12A optional, default 1A;

Precautions:

When send UM1 instruction and set the UPS into a standard model, the charging current defaults to 1A and cannot be modified.

5. Faults and warning instructions

5-1 Description of the fault

Fault: The UPS enters Fault mode and the LCD displays the fault code.

The fault code table

Fault code	English meaning	Related actions	Trigger condition	Recovery condition
1	Busbar boost soft start failure	Turn to fault mode	When the busbar starts soft, the 30S cannot reach 380V	Unrecoverable
2	Busbar over voltage	Turn to fault mode	When the busbar is above 450V, it will last 5s	Unrecoverable
3	Busbar undervoltage	Turn to fault mode	When the busbar is below 200V, it will last 400ms	Unrecoverable
4	DC boost failure	Turn to fault mode	DC-DC hardware protection that triggered the exception	Unrecoverable
8	Battery relay short circuit	Turn to fault mode	Battery voltage is greater than 310V and lasts for 4s	Unrecoverable
9	Busbar soft start relay failure	Turn to fault mode	The bus relay is still below 50V after 5s soft start	Unrecoverable
10	Bus bar short circuit	Turn to fault mode	During normal operation, the mother is instantaneously below 180V	Unrecoverable
17	Inverter soft start failure	Turn to fault mode	After inverting soft start 40s, the rated output voltage cannot be reached, or after inverting soft 2s, the inverter voltage is still less than 20V.	Unrecoverable
18	Inverter output overvoltage	Turn to fault mode	The inverter voltage is higher than 276V and lasts 400ms	Unrecoverable
19	Inverter output undervoltage	Turn to fault mode	The inverter voltage is below 130V and lasts 400ms	Unrecoverable
20	Inverter short circuit	Turn to fault mode	The inverter voltage is less than 50V, the current is higher than 20A, and lasts 4s	Unrecoverable
26	Negative power protection	Turn to fault mode	Inverter power is less than -2400W for 20ms, or -800W for 120ms	Unrecoverable
33	Inverter relay open	Turn to fault mode	When the inverter relay is closed, the difference between the inverter voltage and the output voltage exceeds 30V for 160ms	Unrecoverable
34	Inverter relay short circuit	Turn to fault mode	When the bypass relay is closed, the inverter relay is disconnected and the inverter bridge is not working, the difference between the inverter voltage and the bypass voltage is less than 30V	Unrecoverable
35	Bypass relay open	Turn to fault mode	When the bypass relay is closed, the difference between the bypass voltage and the output voltage exceeds 30V for 160ms	Unrecoverable
36	Bypass relay short circuit	Turn to fault mode	When the bypass relay and the inverter relay are disconnected, the difference between the output voltage and the bypass voltage is less than 30V for 160ms	Unrecoverable
37	Input and output reversed	Turn to fault mode	When the bypass relay and the inverter relay are disconnected, the bypass voltage is less than 20V, but the output voltage is greater than 150V	Unrecoverable
39	Charger short circuit	Turn to fault mode	The battery voltage is less than 50V and the charging current is higher than 4A	Unrecoverable
66	Overload fault	Turn to fault mode	The load exceeds the specification	Unrecoverable
67	Reverse battery	Turn to fault mode	The battery input is reversed	Unrecoverable
68	Model recognition error	Turn to fault mode	Undefined machine model	Unrecoverable
73	No bootloader	Turn to fault mode	No boot program	Unrecoverable

5-2.Warning Instruction

Warning: The UPS does not enter the failure mode, and the LCD displays an alarm code.

Warning Code Description

Warning Code	English Meaning	Linked Active	Triggering Conditions	Recovering Conditions
1	Battery is not connected	Warning, battery discharge	Battery voltage less than 8V/PCS	Recoverable(10V/PCS)
2	Low voltage in battery	Warning, battery test models return to main model	Default 11.2/pcs, Custom settings 10.5-14V/PCS(2)	Recoverable (Action point +0.2V/pcs)
3	Charging short circuit	Warning, No charging to batteries	The battery voltage is lower than 5V/pcs,current is more than 4A	Unrecoverable
4	Mains L/N reverse connection or the ground wire is not connected	Warning	Hardware trigger	Reconnect the L/N of the mains power after power failure, check whether the ground wire is connected, or send a communication command to prohibit L/N reverse connection
8	High voltage in battery	Warning, battery discharge	Default 11.2/pcs, Custom settings +0.4V/PCS	Recoverable (Default 13.7V/PCS, custom settings +0.4V/pcs)
9	Charger failure	Warning	After 5 minutes of charging, the battery voltage is still less than 10V	Recoverable (battery voltage more than 10.5V)
10	Over-temperature warning	Warning, battery discharge	PFC or INV temperature sensor is higher than 80 degrees Celsius	Recoverable (The temperature sensor is below 75 degrees Celsius)
12	Fan failure	Warning	No fan speed signal detected	Recoverable
13	Mains disconnect	Warning	The difference between the mains voltage and the bypass voltage is greater than 100V	Recoverable
14	EEPROM failure	Warning	EEPROM read and write failed	Unrecoverable
18	Inverter output overvoltage	Warning, battery discharge	load more than 102%	Recoverable (overload less than 97%)
21	overload	warning	the load higher than 102%	Recoverable (load lower than 97%)
22	Overload lock in bypass	Warning	3 times of overload transfer to bypass mode in 30 minutes	Manual boot can be restored
23	EPO action	Warning, battery discharge		Recoverable
24	Maintenance switch action	Warning	Short circuit of CN4 terminal on control board	Recoverable

The pictures or diagrams involved in this manual are for reference only. Please refer to the actual product in the end. Specifications are subject to change without notice.

6. Technical parameters

Model		6KVA	10KVA
Capacity		6000VA/5400W	10000VA/9000W
Input			
Voltage Range	Minimum switching voltage	At 50% load, 110VAC±3%; at 100% load, 176VAC±3%	
	Minimum recovery voltage	Minimum switching voltage +10V	
	Maximum switching voltage	300VAC±3%	
	Maximum recovery voltage	Maximum switching voltage -10V	
Frequency Range		40~60HZ@50HZ system/50~70HZ@60HZ system	
Phase		L+N+PE	
Power Factor		100% load≥0.99	
Output			
Output Voltage		208/220/230/240VAC	
Output Voltage Accuracy		±1%	
Frequency Range (synchronization range)		40~60hz@50HZsystem/50~70HZ@60HZsystem	
Frequency Range (battery mode)		50hz±0.1HZor60HZ±0.1HZ	
Overload	AC Mode	30min@102%~110%load, 10min@110%~130%load 30s@130%~150%load, 500ms@>150%load	
	Battery Mode	10min@102%~110%load, 1min@110%~130%load 10s@130%~150%load, 500ms@>150%load	
Current peak ratio		3:1 (Maximum)	
Harmonic distortion		≤2% (linear load) , ≤5%(non-linear load)	
Switching time	Mains ↔ Battery	0ms	
	Inverter ↔ Bypass	0ms	
Effectiveness			
AC Mode		95%	
Battery Mode		94.8% (20pcs batteries)	
Battery			
Standard	Battery Number	12-16 pcs	16 pcs
	Charging Current	default 1A	
	Charging Voltage	13.65×N±1%	
Long Run	Battery Number	16 ~ 20 pcs	
	Charging Current	Preset: 6A±10%, 1-12A optional	
	Charging Voltage	13.65×N±1%	
Apperance			
Standard	Size Long×Width×High(mm)	384×190×730	
Long Run	Size Long×Width×High(mm)	384×190×335	
Environment			
Operating Temperature		0 ~ 40°C	
Operating Moisture		< 95%And no condensation	
Operating Altitude		< 1000m**	
Noise		less than 50dB@1Meter	
Management			
SmartRS-232		Support Windows@2000/2003/XP/Vista/2008、Windows@7/8、Linux、Unix and MAC	
Optional SNMP		Support for power management by SNMP administrator and web browser.	

*When the output voltage is set to 208VAC, the output power will be reduced to 90%.

**If the UPS is installed and used in an environment with an altitude of more than 1000 meters, the output power should be calculated to decelerate by 1% per 100 meters.

***Please understand that there will be no notice when product specifications are changed.

7. Storage and maintenance

7-1. Storage

Please charge for 7 hours before storing this product. Store it upright in a dry place.

During storage, please perform charging maintenance according to the following table:

Storage temperature	Charging interval	Charging time
-25°C - 40°C	Every 3 months	1 to 2 hours
40°C - 45°C	Every 2 months	1 to 2 hours

7-2. Maintenance



The UPS system uses dangerous voltage and can only be repaired by qualified maintenance personnel.



There is a danger of electric shock. Even if the main power supply is disconnected, the components in the UPS system are still connected to the battery and are dangerous.



To perform any service or maintenance, you should disconnect the battery first and confirm that there is no dangerous voltage across the bus capacitor.



Only maintenance personnel who are fully familiar with batteries and have prepared protective measures can engage in or supervise battery replacement operations. Unauthorized personnel must stay away from the battery.



There is a risk of electric shock. The battery circuit is not isolated from the mains input. Dangerous voltage may appear between the battery terminal and the ground. Before touching, please make sure there is no voltage!



The battery may cause electric shock and generate short-circuit high current. Before repairing, please remove metal objects such as watches and rings, and use tools with insulator handles and handles during repairs.



When replacing batteries, please install batteries of the same number and specifications.



Do not throw the battery into the fire, otherwise it may cause an explosion. Waste batteries should be disposed of in accordance with local regulations.



Do not disassemble or damage the battery. Once the electrolyte contained in the battery leaks, it will cause damage to the skin and eyes, and may even be toxic.



Only replace fuses of the same type and amperage to avoid fire.



Non-professionals should not disassemble the UPS system.

A large, stylized orange letter 'M' logo, composed of three vertical bars and two diagonal bars meeting at the top.

MEDALPOWER

www.medal-power.com