



**MEDALPOWER**

# **Uninterruptible Power Supply(UPS)**

**1KVA**

***Line interactive UPS***

**MP-LU1000VA#4B7T**



[www.medal-power.com](http://www.medal-power.com)



## **Thank you for choosing our products!**

Please read all safety and operating instructions before using, obey strictly the warnings and operating instructions, and keep this manual after reading.



# Catalogue

<b>I. Safety instructions.....</b>	<b>1</b>
<b>II. Installation.....</b>	<b>2</b>
<b>III. Operating and Operation.....</b>	<b>8</b>
<b>IV. Maintenance.....</b>	<b>12</b>
<b>V. Audible alarm and LED indication.....</b>	<b>13</b>
<b>VI. Troubleshooting .....</b>	<b>15</b>
<b>VII. Attention to handle with the battery.....</b>	<b>21</b>
<b>Appendix I . EMC grade standard.....</b>	<b>21</b>
<b>Appendix II . Description of commonly used symbols.....</b>	<b>22</b>
<b>Appendix III. Product Specifications.....</b>	<b>23</b>
<b>Appendix IV . Communication Interface .....</b>	<b>25</b>
<b>Appendi V . Functions of intelligent software management... </b>	<b>25</b>

## I . Safety Instructions

- ◆ Even though the UPS not connected to utility power, it is possible that there is 220VAC output in its outlets.
- ◆ If you need to change battery cord or power cord, please purchase it from our service center or local distributor, in case to cause heat or fire because of under capacity.
- ◆ Do not incinerate battery or batteries, they may explode.
- ◆ Do not open or mutilate the battery or batteries, released electrolyte is highly poisonous and harmful to our health.
- ◆ Do not short the positive and negative of battery electrode. Otherwise, it may cause shock or fire.
- ◆ The case of the UPS must not be opened by untrained personnel. Otherwise, it may cause electric shock.
- ◆ Keep away from the battery connector. Because between the connector and the ground may lie in the high voltage.
- ◆ For the safety of UPS,it is not recommended for using equipments, like blower and heating appliance.
- ◆ Please do not overload the UPS beyond its designed capacity.

### Attention:

- ❖ There are dangerous voltage inside of UPS, to avoid injury and personnel safety, if there are any problem with UPS, please contact with distributor's technician, don't repair it by yourself.

## II . Installation

### 2.1 Unpacking inspection

- (1) After unpacking, the package should include
  - A piece of UPS
  - A copy of UPS User Manual
  - One input power cord
  - One interface cord and software CD
  - One external battery cord for long backup UPS
- (2) Check it if there is any damage to the device during transit. If there is any damage or missing components, do not use the device, please contact the distributor immediately.
- (3) Check the machine whether you purchase or not according to model number and serial number on rear panel.

MODEL	TYPE
1KVA	STANDARD BACKUP
2KVA	STANDARD BACKUP
3KVA	STANDARD BACKUP

**Attention:**

- ❖ Please reserve the package and package material for future usage.
- ❖ The UPS is heavy, so please handle with care.

**2.2 Installation Notes**

(1) Do not store or use the device in the following environment:

Where there is inflammable gas, corrosive agents or heavy dust.

(2) The UPS should not be tilted. The air inlet port at the front panel and the outlet port on the rear panel and two side panels should not be blocked so as to ensure good ventilation.

(3) where the temperature is should be within 0°C-40°C.

(4) In case if the UPS is unpacked, installed and used at very low temperatures, condensations of water drops may appear. It is necessary to wait until the UPS fully dried inside out before proceeding to installation and use. Otherwise, they may be a risk of electric shock.

(5) Place the UPS near the utility power source outlet which supplies power to the UPS. In any emergency, switch off the main input socket, cut off the battery voltage input. All power sockets must be connected with ground protection.

**Attention:**

- ◆ Ensure all the connected load devices in shut-off start to connect the UPS, then turn on the devices one by one
- ◆ Please connect the UPS to the special socket with “over current protection” purpose.
- ◆ All sockets must be connected to the earth wire end of protection
- ◆ No matter how the power cord plugs in the socket or not, the UPS will possibly carry current as usual, only switch off the utility power can cut off the UPS output.

- ◆ For the standard type UPS please charge the battery at least 8 hours before use, as long as connect the UPS to utility power it will charge automatically. It is Okay to use the UPS without charge though the backup time will be less than standard hour.
- ◆ If the UPS is connected to the inductive load with high power such as electric motor, monitor, laser printer, the UPS power should be customized according to the initial power which is about twice of the rated power.

### 2.3 The Appearance of the UPS

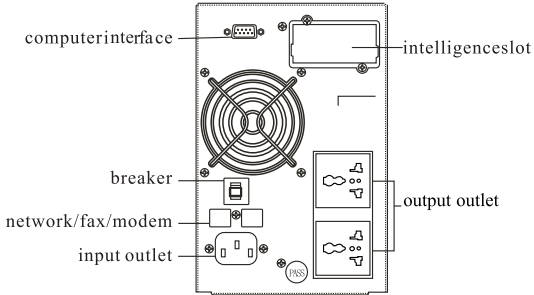

photo 2-1 1KVA REAR PANEL

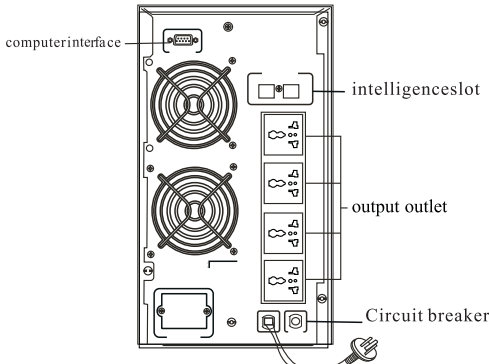

photo 2-3 2KVA REAR PANEL

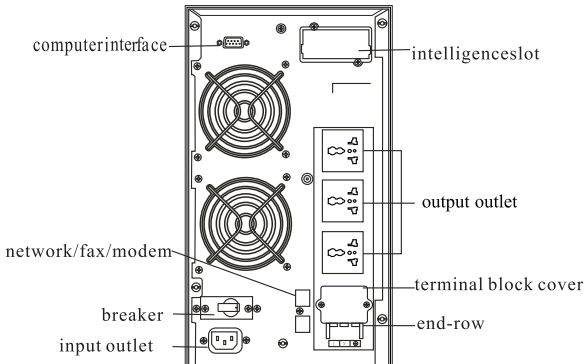

photo 2-5 3KVA REAR PANEL



## 2.4 Descriptions of indicators

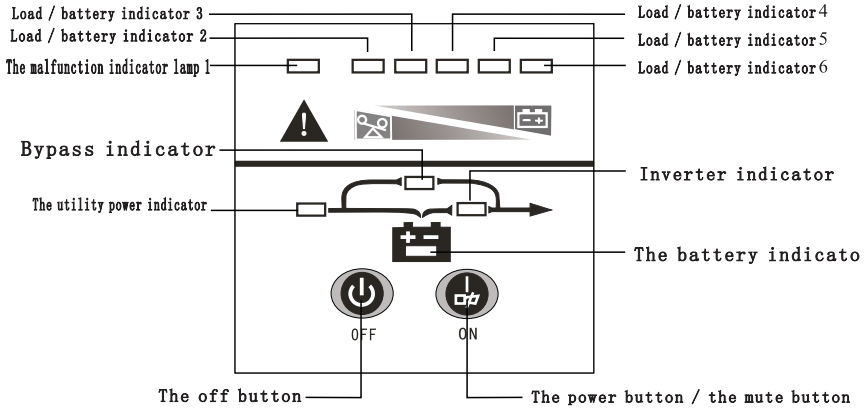

photo 2-7 LED

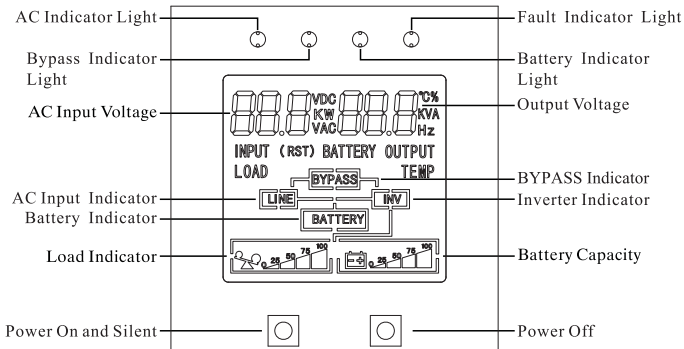

photo2-8-1 LCD

- **Power switch:** keep on pressing the “ON” key on the front panel for at least one second to turn on the UPS; keep on pressing the “OFF” key on the front panel for at least one second to shut down the UPS.
- **Bypass indicator:** When the indicator on, it shows that the loading current is supplied from the utility power directly.
- **Inverter indicator:** When the indicator on, it shows that the load current is supplied from utility power or battery via the inverter.
- **Battery indicator:** When the indicator on, it shows that the load current is supplied from battery via the inverter.
- **Fault indicator:** When the indicator on, it shows that the UPS is in an abnormal condition.
- **Load indicator (battery capacity indicator):** it shows the percentage of the load capacity (battery capacity).

■ Normal mode:

Indicators	Load capacity percentage
2#	Above96%
3#	71-95%
4#	51-70%
5#	31-50%
6#	0-30%

■ Battery mode:

Indicators	Battery capacity percentage
2#	0-25%
3#	26-50%
4#	51-75%
5#	76-100%
6#	Above100%

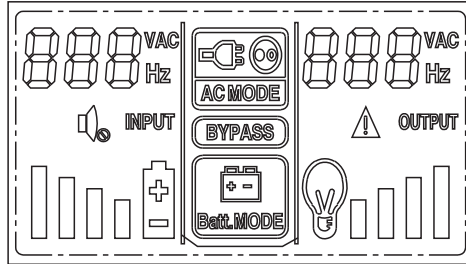

photo2-8-2 LCD

LCD Display	Functions
	Display the mains Input&Output voltage and frequency.
INPUT	Display the mains Input
OUTPUT	Display the UPS Output
	Display the UPS faulty
	Display battery capacity
	Display battery load
	Display UPS in battery mode
	Display UPS in mains mode
	Display UPS in mute mode

## 2.5 Input cable connection

If the UPS is connected via the power cable, please use a proper socket with protection against electric current, and pay attention to the capacity of the socket: over 10A for 1KVA , over 16A for 2KVA and 3KVA.

The wiring configuration is shown in the following diagram.

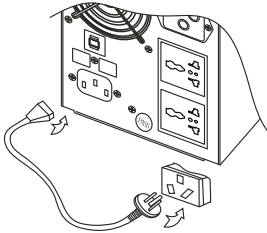

photo 2-8 1KVA-3KVA INPUT

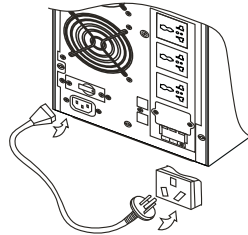

photo 2-9 1KVA-3KVA OUTPUT

## 2.6 Output connection

Model	Quantity of Output Socket	Output Terminal Block
1KVA	2	Nil
2KVA	4	Nil
3KVA	3	Available

(1)The output of 1KVA/ 2KVA/ 3KVA all available to uses sockets. Simply plug the load power cable to the output sockets of UPS to complete connection as shown in the following diagram.

(2) Apart from using the socket for output, 3KVA has the terminal block available for output.

The wiring configuration is shown in the following diagram.

- 1) Remove the cover of the terminal block;
- 2) Use AWG14 (2.1mm<sup>2</sup>) wires for wiring configuration;
- 3) Upon completion of the wiring configuration, please check whether the wires are securely affixed;
- 4) Put back the terminal block cover to the rear panel.

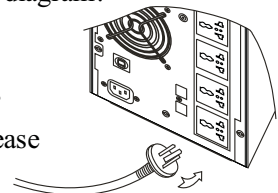

photo 2-10 3KVA terminal block output

## 2.7 Operation Procedure of External Battery for Long Backup Time UPS

**The battery connection procedure is very important. Any incompliance may result in the risk of electric shock. Therefore, the following steps must be strictly complied with.**

- 1)First connect in series the batteries of the pack to ensure proper battery voltage that 1KVA for 36VDC, 2KVA for 72VDC, 3KVA for 96VDC.
- 2)Take out the battery cable delivered with the UPS, one end of the external battery cable is a plug for connecting the UPS, the other end has 3 open wires for connecting the battery pack.
- 3)Connect the external battery cable to the battery terminal (DO NOT connect the battery socket of the UPS first. Otherwise, it may cause electric shock). Connect the red wire to the “+” terminal of the battery. The black wire is connected to the “-” terminal of the battery. The green/yellow wire is grounded for protection purpose.
- 4)Please do not connect any load for UPS before connect power cord well and provide AC to UPS.
- 5)Connect the plug of the external battery cable to the external battery socket on the rear panel of the UPS to complete the connection procedure.

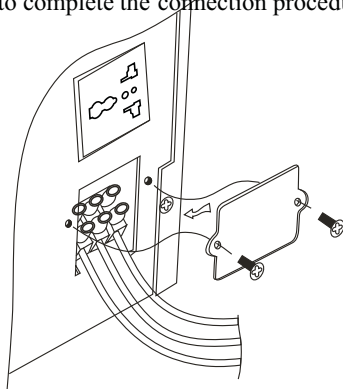

Photo2-11 Battery connection diagram for Long Backup time models

### III. Operating and Operation

Please read this Manual carefully before using.

#### 3.1 Operating Instructions

##### 1. Turning on with utility power

1) Connect the mains input to the UPS, it can set kinds of UPS function through monitoring software.

2) Press and hold the “ON” button for 1 second until the buzzer beeps.

3) At this point, the UPS begins to conduct self-diagnosis, with the load/battery capacity indicators on the front panel turned on and then off one after another. Seconds later, the UPS will begin to operate in Normal mode; meanwhile, the utility power indicator, inverter indicators will turn on. If the utility power is abnormal, the UPS will work in battery mode.

##### 2. Turning on without utility power

1) With no mains input feed to the UPS, hold and press the “ON” button for 1 second until the buzzer beeps.

2) In the power on process, the UPS has the same operation as if it is connected to utility power except that the utility power indicator is not turned on and the battery indicator is turned instead.

##### 3. Completely power off the UPS from Normal mode

1) Hold and press the “OFF” button persistently for more than 1 second to power off the UPS.

2) At this point, the UPS begins to conduct self-diagnosis, with the load/battery capacity indicators on the front panel turned on and then off one after another. Meanwhile, inverter indicators will turn off, the bypass indicator will turn on, the UPS will begin to operate in bypass mode;

3) After finish above steps, the UPS is working in bypass mode. In order to cut off the output from the UPS, simply cut off the utility power supply. Finally, not any display is shown on the front panel and no output is available from the UPS outlets.

## 4. Completely power off the UPS from Battery mode

1) Press the “OFF” button persistently for more than 1 second to power off the UPS.

2) When being powered off, the UPS will start self-diagnosis and all the load/battery capacity indicators will be turn on and off one after another. Finally, not any display is shown on the front panel and no voltage output is available from the UPS outlets.

## 3.2 Operation

### 3.2.1 Normal mode

**In the normal mode, the display on the front panel is shown in the following diagram. The utility power indicator and the Inverter indicator are turn on. The load/battery capacity indicator will be turned on in accordance with the load capacity connected.**

1) If the utility power indicator blinks, it indicates that there are problems with reversed polarity (L, N) of site wiring or disconnect with ground that may result in shock hazard. UPS is still working in normal mode. If the battery indicator is turn on at the same time, it shows that the voltage or frequency of the utility power is out of the normal input range of the UPS. The UPS works in battery mode.

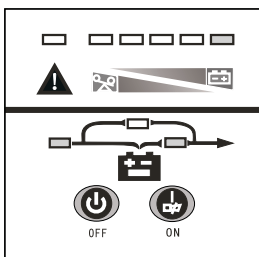

(LED)

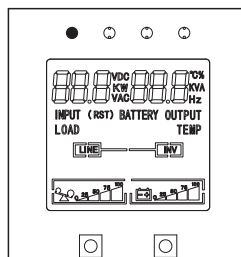

(LCD)

Photo3-1 Normal mode

2) If output overloaded, the load level indicators will be turned on and alarm will beep twice every second. You should get rid of some unnecessary loads one by one to decrease the loads connected to the UPS less than 100% capacity of the UPS.

3) If the battery indicator blinks, it indicates that no battery is connected to the UPS or battery voltage is too low. You should check if battery is properly connected to the UPS. If the connection between battery and UPS is confirmed without any problem, it may be due to the defect or aging of the battery, please refer to the “troubleshooting” in chapter 6 to solve the problem accordingly.

**Note:**

**Connection to the power generator should be made according to the following steps:**

- ◆ Activate the power generator and wait until the operation is stable before connecting the output of the power generator to the UPS (be sure that the UPS is in idle mode). Then, turn on the UPS according to the start-up procedure. After the UPS is turned on, the loads are connected one by one.
- ◆ It is recommended that the capacity of the generator chosen should be double of the UPS.

### 3.2.2 Battery mode

**In battery mode the display on the front panel is shown in the following diagram. The battery indicator and the inverter indicators are on. If the utility power indicator blinks at the same time, it shows that the utility power is abnormal. The battery capacity indicators will be on in accordance with the battery capacity. Please note that the load capacity indicator in AC mode will indicate the battery capacity.**

1) When the ups is running in battery mode, the alarm will beep every 4 seconds. If the “ON” key is pressed for more than 1 seconds, the alarm will not beep (silence function). Press the “ON” key more than 1 seconds again to resume the alarm function.

2) When the battery capacity decreases, the number of battery capacity indicators turned on will decrease. If the battery voltage drops to the pre-alarm level (capable of maintaining the backup time for more than 2 minutes), the alarm will beep every second to remind the user of insufficient battery capacity and reduce the load one by one.

3) check the backup function via the UPS without utility power .

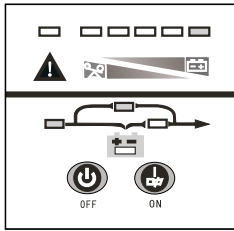

(LED)

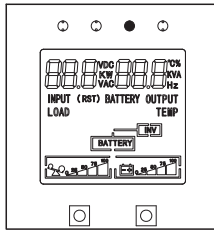

(LCD)

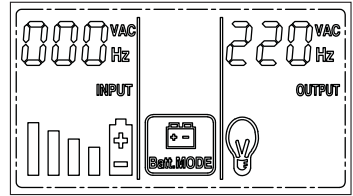
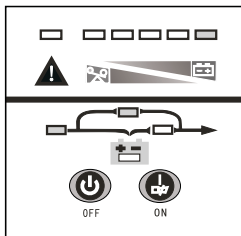

Photo3-2 Battery mode

### 3.2.3 Bypass mode

**When operating in bypass mode set up through WinPower software, the display on the front panel is show in the following diagram. The utility power indicator and the bypass indicator are on. The load capacity indicator will be on in accordance with the load capacity connected. The UPS beeps every 2 minutes.**

- 1) If the utility power indicator blinks, it shows that the voltage or frequency of the utility power is out of the input range of the UPS or there are problems with reversed polarity (L/N) of site wiring or disconnect to the ground for protection.
- 2) Other display on the front panel is same as those mentioned in normal mode.
- 3) When operating in bypass mode, the backup function of the UPS is not available and the power used by the load is directly from the utility power via internal EMI filter.



(LED)

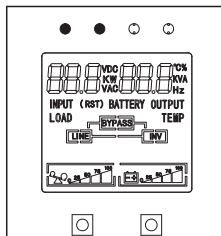

(LCD)

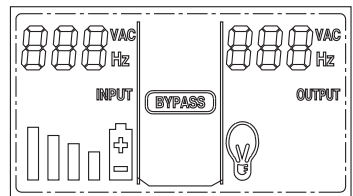

Photo3-3 Bypass mode



### 3.2.4 Abnormal mode

If the fault indicator is on during operation, the UPS is in abnormal mode. Its handling methods are referred to chapter 6.

## IV. Maintenance

1) The series UPS only needs minimal maintenances and is easy to use. Sealed maintenance free lead acid battery be used in the standard.. The only requirement is to recharge the UPS regularly to maximize expected service life. When being connected to the utility power whether the UPS has been turned on or not, the UPS keeps charging the battery and also offers the protective function of charging and discharging.

2) If the UPS has not been used for a long period, charging is recommended at the intervals 3 months.

3) Under normal conditions, the battery life lasts 3 to 5 years. In case if the battery is found not in good condition, earlier replacement should be made. The battery should only be replaced by qualified service personnel.

4) Batteries should not be replaced individually All batteries should be replaced at the same time following the instruction of the battery supplier.

5) Normally, the battery should be charged and discharged every 4 to 6 months.

Charging should be begin after the UPS discharged & shut down automatically .

6) In the regions of hot climates, the battery should be charged and discharged every 2 months. Moreover, the standard charging time should be not less than 12 hours.

### Note:

- ◆ Prior to battery replacement, the UPS must be turned off and disconnected from utility power.
- ◆ Metal objects such as rings and watches should be removed.
- ◆ Use the screwdriver with insulated handle. Tools and other metal objects should not be placed on the battery.
- ◆ Short circuit or reverse connection between the positive and negative terminal of the battery is strictly forbidden.

## V . Audible alarm and LED indication

Warning light indications:	Alarm types	UPS fault types	remarks
1#,6# light on	continually ring	over-temperature	Battery mode: 1#,6# light on, AC Mode : 1#,6# light on, AC & bypass light on
1#,5# light on	continually ring	Output short circuit	Battery mode: 1#,6# light on, AC mode 1#,6# AC power light on
		Inv Fault	Battery Mode: 1#,5# light no, AC mode 1#,5#,AC power light on
1#,4# light on	continually ring	Bus Fault	Battery Mode: 1#,4# light no, AC Mode: 1#,4#,AC power,bypass light on
1#,3#,AC power,battery,inverter light on	continually ring	Over charge	The UPS work in battery mode don't pull out the battery cord to protect the connected load from outage
1#,2#,battery light on	continually ring	Overload in battery mode	
1#~6#,Mains,bypass light on	continually ring	Overload in AC Mode	
Mains light flashes twice per-second		AC power supply is in abnormal condition	starting up the UPS in battery mode accompanied with 8 beep sounds

Warning light indications	alarm types	UPS condition	remarks
battery light flashes twice per second		The UPS finds no connection to batteries	6 continual alarm sound comes while starting up the UPS
2#~6# light on	two continual alarm sounds per second	UPS is under overload state	
1# light on,battery light flashes twice per second	one alarm sounds per second	there is fault in charging board	
2#,battery light on	one alarm sounds per second	Battery low voltage	
city power light flashes twice per second	one alarm sound every two minutes	reverse connection of AC power's "L" and "N"	
Mains,bypass, battery, light on in order		batteries are under check up by UPS	Press "OK" button for one second under normal operation,the UPS will check up the batteries automatically and please keep power supply to prevent connected load from outage
6#,AC power ,bypass light on	one alarm sounds every two minutes	UPS has transferred to bypass	

## LCD audible alarm

Display error code warnings	Alarm types	UPS fault types	Remarks
error code FAL 1 6	UPS long beeping	Over temperature FAULT	FAL 1 6
error code FAL 1 5	UPS long beeping	Output short circuit FAULT	FAL 1 5
		INV FAULT	
error code FAL 1 4	UPS long beeping	BUS FAULT	FAL 1 4
error code FAL 1 3	UPS long beeping	Over charging FAULT	FAL 1 3
error code FAL 1 2	UPS long beeping	Overload in battery mode FAULT	FAL 1 2

## VI. Trouble shooting

**There are list some possible questions and solutions when use this series of UPS, use this information to determine whether UPS failure caused by external factors and how to correct.**

- Fault LED on, means UPS have inspected fault.
- Buzzer beeps means you should pay attention to the UPS.
- Several load/battery indication on, help operator to make a diagnosis.
- Front panel indication series no. as below diagram:

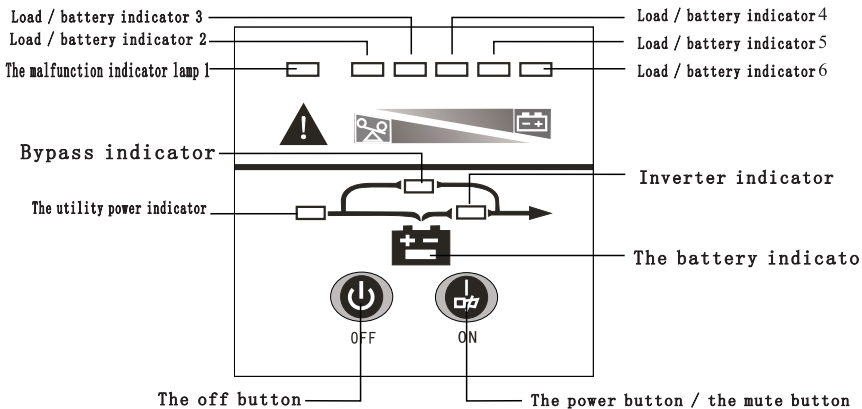

photo 6-1 front panel display

**In the event of an UPS fault, shoot the trouble according to Table 6-1. If the fault still persists, please contact the customer service center.**

Table 6-1 UPS troubleshooting

Problem	Possible cause	Solution
The #1 Fault LED and #6 LED are on,the buzzer beeps continuously.	Internal overheat	Ensure that the UPS is not overloaded and the ventilation opening is not blocked and ambient temperature is not too high. Wait for 10 minutes for the UPS to cool down before turning it on again.If it does not work. please contact the distributor or work. please contact the distributor or work. Please contact the distributor or service center
The #1 Fault LED and #5 LED are on,the buzzer beeps continuously.	UPS circuit or Internal fault	Shut off the UPS ,pull out all the load, conrirm load no short coircuit then restart on.It still existed,please contact the distributor or Service center
The #1 Fault LED and #4 LED are on,the buzzer beeps continuously.	Internal fault	Please contact the distri butor or Service center
The #1 Fault LED and #3 LED are on,the buzzer beeps continuously.	Over-charging protection	The charger of the UPS is defective . Please contact the distri butor or Service center

The #8 utility power LED blinks	The voltage or frequency of the utility power is out of the input range of the UPD (when being activated, the UPS beeps twice every second for 8 times)	The UPS running in the battery mode. TO save you data and then close the application in use. Ensure that utility power is within in the input voltage frequency range permitted by the UPS
	Maybe reversed polarity (L,N)of site wiring. The alarm beeps once every 2 minutes	Please check the polarity of the neutral wiring and the line wiring
The #1 Fault LED and #2 LED are on, the buzzer beeps continuously	The UPS overloaded or the load device is faulty in battery mode	Check the load and remove the non-Critical device. Recalculate the load power and reduce the load connected to the UPS . Check whether the load device is fault
The #10 battery LED blinks	Battery is not connected or its voltage is too low.	Check the battery of the UPS and connect it properly. If the battery is damaged, you must replace it promptly
The #1 fault LED is on. The #10 battery LED is blinks. The buzzer beeps once every second	The charger of the UPS is defective	Please contact the distributor or Service center

<p>The utility power normal and the UPS cannot run in normal mode</p>	<p>The UPS input breaker is tripped</p>	<p>Reset the input breaker</p>
<p>The battery discharge time diminishes</p>	<p>The battery has not been fully charged</p>	<p>Keep the UPS connected to utility power persistently for more than 10 hours to charge the battery again</p>
	<p>The UPS is overloaded</p>	<p>Check the load status and remove the non-critical device</p>
	<p>Battery aged</p>	<p>Replace the batteries. Please contact the distributor to obtain the replacement components for battery</p>
<p>The UPS cannot power on after pressing the power on key</p>	<p>The "ON/OFF" button is pressed to briefly</p>	<p>Press the "ON/OFF" button persistently for more than 1 second</p>
	<p>The UPS is not connected to battery or the battery voltage is too low</p>	<p>Check the connection of the battery. Turn on the UPS without load if the battery voltage is low</p>
	<p>Internal fault</p>	<p>Please contact the distributor or Service center</p>

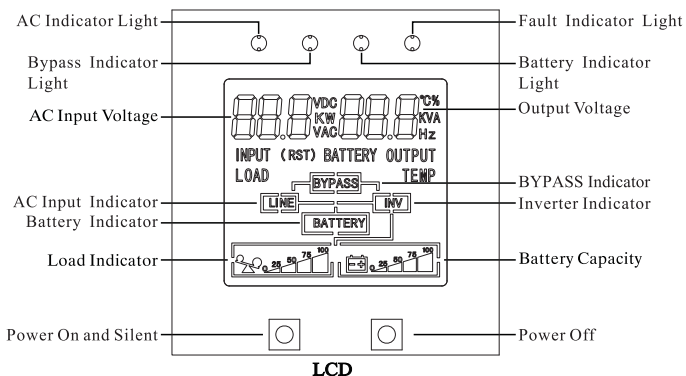

LCD

## UPS troubleshooting

Problems	Possible causes	Solutions
error code FAL 1 6	Internal overheat	Ensure that the UPS is not overload,the ventilation opening is not blocked and indoor temperature is not too high.Wait for 10 minutes to make the UPS cool down,then restart it.If failure,please contact the distributor or service center
error code FAL 1 5	Output short circuit or internal fault	Shut off the UPS,remove all the load and confirm the load no faulty and short circuit. Then restart the UPS.If failure,please contact the distributor or service center
error code FAL 1 4	Internal fault	Please contact the distributor or service center
error code FAL 1 3	Over charging protection	UPS charger is defective,please contact the distributor or service center
Mains indication blinks	The voltage or frequency of the utility power is beyond UPS input range (when booting,UPS beeps twice every second for eight times)	The UPS is working in battery mode at the moment.Please save your data and close the application programs.Then ensure that the utility power is within the UPS input voltage range or input frequency range
	L&N reversed,the alarm beeps every two minutes	Remove and reconnect them in the right way
error code FAL 1 2	The UPS is overload or the load device is faulty in battey mode	Check the load and remove the non-critica devices.Recalculate the load power and reduce the quantity of connected load devices to UPS.Check whether the load device is faulty



## UPS troubleshooting

Problems	Possible causes	Solutions
Battery indication blinks	Battery is not connected or its voltage is too low	Check the battery part and make them properly connected.If the battery is damaged,please replace them promptly
The utility power is normal and the UPS cannot run in mains mode	the UPS input breaker is tripped	Reset the input breaker
The battery discharge time diminishes	The battery has not been fully charged	Keep the UPS connected to utility power persistently for more than three hours to recharge the battery
	The UPS is overload	Check the load status and remove the non-critical devices
	Battery aged	Replace the batteries.Please contact the distributor to obtain the replacement components of battery
The UPS cannot power on after pressing the power on key	Time of pressing "ON/OFF" button is too short	Press the "ON/OFF" button persistently for more than one second
	The UPS is not connected with battery or the battery voltage is too low and power on with load	Check the battery connection.Turn on the UPS without load if the battery voltage is low
	Internal fault	Please contact the distributor or service center

**When reporting UPS fault, please provide the following information: The machine model and serial No.**

- The data of fault happened.
- The detail of fault, contains LED indications, power condition, load capacity, buzzer beeps and configuration of battery (if it is the Long Backup time UPS).

## **VII . Attentions to handle with the battery**

1. Before handling the battery, please unfix the metal articles, such as the ring, watch.
- 2.If you need to renew the battery cable, please buy the raw materials from the service stations or the agency, to avoid the fire caused by low- capacity.
- 3.Do not incinerate batteries, otherwise will explode wounding.
4. Do not open or mutilate the batteries, released electrolyte is highly poisonous and harmful to human.
5. Do not short the positive and negative of battery electrode. Otherwise, it may cause shock or fire.
- 6.Keep away form the battery connector. Because between the connector and the ground may lie in the high voltage.
7. Maintenance of battery, please refers to the “IV. Maintenance”













## **APENDIX I . EMC Grade Standard**

The series UPS are manufactured according to EMC Grade Standard:

Standard serial number	grade
CB9254-1998/EN55022	A
IEC1000-4-2	4
IEC1000-4-3	3
IEC1000-4-4	4
IEC1000-4-5	2

## APPENDIX II . Description of commonly used symbols

The following symbols may be used in this manual and may be appear in your application process. Therefore, all users should read the form carefully and thoroughly.

Symbols and Description	
Symbol	Description
	Attention
	Dangerous voltage
	Power on
	Power off
	Standby or power off
	Alternating current (AC)
	Direct current (DC)
	Protective ground
	Alarm silence
	Overload
	Battery checking
	Recycle
	Keep UPS in clear area

## APPENDLX III .Product Specification

### Electrical Specification

Model	1KVA	2KVA	3KVA
Nominal Power Capacity	1000VA/800W	2000VA/1600W	3000VA/2400W
Nominal Voltage	220/230/240VAC		
Nominal Frequency	50Hz		

### Input

Model	1KVA	2KVA	3KVA
Voltage(single phase)	(118~300VAC±5VAC)load<50% (140~300VAC±5VAC)50%≤load<70% (160~300VAC±5VAC)load≥70%		
Frequency Range	40~60Hz(adjustable)		
Power Factor	≥0.95	≥0.97	

### Output

Model	1KVA	2KVA	3KVA
Voltage	220Vac±2%		
Frequency	1:Synchronized 46~45Hz 2: lower than 46Hz or higher than 54Hz , output frequency lock on 50Hz.		
Distortion	≤3%(Full linear load)	≤4%(Full linear load)	
Overload Capability	105%±5%<Load≤150%±5% >30seconds transfer to bypass and alarm. 150%±5%<Load≤200%±5% >300ms transfer to bypass and alarm		
Crest Ratio	3:1		

### Battery voltage

Model	1KVA	2KVA	3KVA
Nominal battery Voltage	24/36VDC	48/72/96VDC	72/96VDC

### Backup time

Model	Full load(mins)	Half load(mins)
1KVA	$\geq 5$	$\geq 10$
2KVA	$\geq 5$	$\geq 15$
3KVA	$\geq 4$	$\geq 10$

### Transfer time

Model	1KVA	2KVA	3KVA
AC mode bypass mode	$\leq 4\text{ms}$ (standard time 2.5ms)		
AC mode battery mode	0ms		

### Operation environment

Model	1KVA	2KVA	3KVA
Operating Temperature	0~40°C		
Operating Humidity	0~95% non-condensing		
Altitude	$\leq 1500\text{m}$		
Storage Temperature	-25°C~55°C		

## APPENDIX IV .Computer Interface

The series UPS provides a standard DB9 outlet.

Every feet of the DB9 is shown as the following:

FEET	MEANING
1	EMPTY
2	SEND
3	RECEIVE
4	EMPTY
5	GND
6	EMPTY
7	EMPTY
8	EMPTY

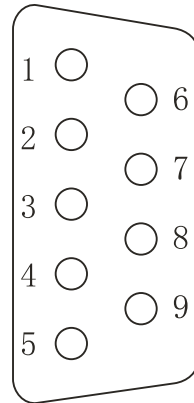

◆ computer interface

## APPENDIX V . Functions of intelligent software management

This series of UPS provides an intelligent slot for the smart card(optional accessory),a dedicated intelligent card can be compatible with the popular software and hardware on today's Internet and network operating systems .can support operating systems such as HP openview,IBM netview,SUN netmanager,make ups immediately with direct Internet,provide timely information of ups and power,through a variety of network management systems for communication,management.





# MEDALPOWER

Leave Power for Medal Power

[www.medal-power.com](http://www.medal-power.com)

