



MEDALPOWER

INVERTER

8000W

Highy Frequency Inverter

MPI-8000W#48VPVT



www.medal-power.com

Table Of Contents

1 About This Manual	1
1.1 Purpose.....	1
1.2 Scope.....	1
2 Safety Instructions	1
3 Introduction	2
3.1 Features.....	2
3.2 Basic System Architecture.....	2
3.3 Product Overview.....	3
4 Installation	4
4.1 Unpacking And Inspection	4
4.2 Preparation	4
4.3 Mounting The Unit.....	5
4.4 Battery Connection.....	6
4.5 Ac Input/Output Connection.....	7
4.6 PV Connection.....	8
4.7 Final Assembly.....	10
4.8 Communication Connection	10
5 Operation	10
5.1 Power On/off.....	10
5.2 Operation and Display Pane	11
5.3 LCD Stting.....	19
5.4 Battery Equalization Description.....	27
5.5 Fantion and alarm descripion.....	29
6 Trouble removeal	30
7 Technical datasjeet	31
Appndix I:Parallel function	32
1 Introduction.....	32
2 PackContens.....	32
3 Parallel board installation.....	32
4 Mounting the Unit.....	35
5 Wiring Connection.....	34
6 PV Connection.....	43
7 LCD Setting and Display.....	44
8 Commissioning.....	45

1 About This Manual

1.1 Purpose

This manual describes the assembly, installation, operation and troubleshooting of this unit. Please read this manual carefully before installations and operations, Keep manual for future reference.

1.2 Scope

This manual provides safety and installation guidelines as well as information on tools and wiring.

2 Safety Instructions



WARNING: This chapter contains important safety and operating instructions. Read and keep this manual for future reference.

1. Before using the unit read all instructions and cautionary markings on the unit, the batteries and all appropriate sections of this manual.
2. **CAUTION**-To reduce risk of injury, charge only deep-cycle lead acid type rechargeable batteries. Other types of batteries may burst, causing personal injury and damage.
3. Do not disassemble the unit Take it to a qualified service center when service or repair is required. Incorrect re-assembly may result in a risk of electric shock or fire.
4. To reduce risk of electric shock, disconnect all wirings before attempting any maintenance or cleaning. Turning off the unit will not reduce this risk.
5. **CAUTION**-Only qualified personnel can install this device with battery.
6. **NEVER** charge a frozen battery.
7. For optimum operation of this inverter/charger, please follow required spec to select appropriate cable size. It's very important to correctly operate this inverter/charger.
8. Be very cautious when working with metal tools on or around batteries. A potential risk exists to drop a tool to spark or short circuit batteries or other electrical parts and could cause an explosion.
9. Please strictly follow installation procedure when you want to disconnect AC or DC terminals, Please refer to INSTALLATION section of this manual for the details
10. One piece of 150A fuse is provided as over-current protection for the battery supply.
11. **GROUNDING INSTRUCTIONS** -This inverter/ charger should be connected to a permanent grounder wiring system. Be sure to comply with local requirements and regulation to install this inverter.
12. **NEVER** cause AC output and DC input short circuited. Do NOT connect to the mains when DC input short circuits.
13. **Warning!!** Only qualified service persons are able to service this device. If errors still persist after following troubleshooting table, please send this inverter/charger back to local dealer or service center for maintenance.

3 Introduction

This is a multi-function Inverter/charger, combining functions of inverter, solar charger and battery charger to offer uninterruptible power support with portable size. Its comprehensive LCD display offers user-configurable and easy-accessible button operation such as battery charging current, AC/solar charger priority, and acceptable input voltage based on different applications.

3.1 Features

- ◆ Pure sine wave inverter
- ◆ Configurable input voltage range for home appliances and personal computers via LCD setting
- ◆ Configurable battery charging current based on applications via LCD setting
- ◆ Configurable AC/Solar Charger priority via LCD setting
- ◆ Compatible to mains voltage or generator power
- ◆ Auto restart while AC is recovering
- ◆ Overload/Over temperature/short circuit protection
- ◆ Smart battery charger design for optimized battery performance
- ◆ Cold start function

3.2 Basic System Architecture

The following illustration shows basic application for this inverter/charger. It also includes following devices to have a complete running system:

- ◆ Generator or Utility
- ◆ PV modules

Consult with your system integrator for other possible system architectures depending on your requirements.

This inverter can power all kinds of appliances in home or environment, including motor-type appliances such as tube light, fan, refrigerator and air conditioner.

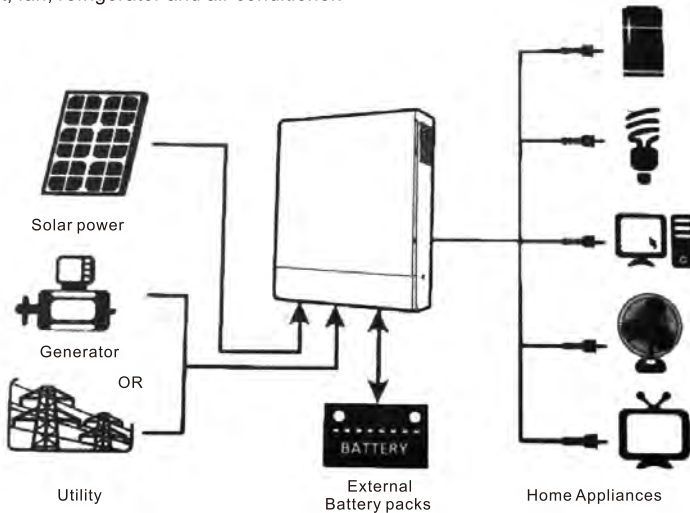

3.3 Product Overview

3.3.1 LCD Screen

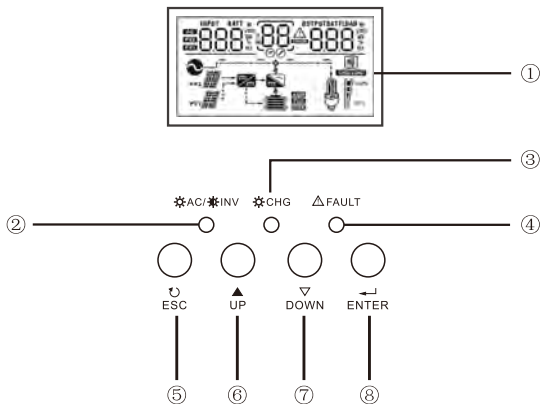

- | | |
|--------------------------|-------------|
| 1.....LCD display | 5.....ESC |
| 2.....Status indicator | 6.....UP |
| 3.....Charging indicator | 7.....DOWN |
| 4.....Fault indicator | 8.....ENTER |

3.3.2 Back Panel

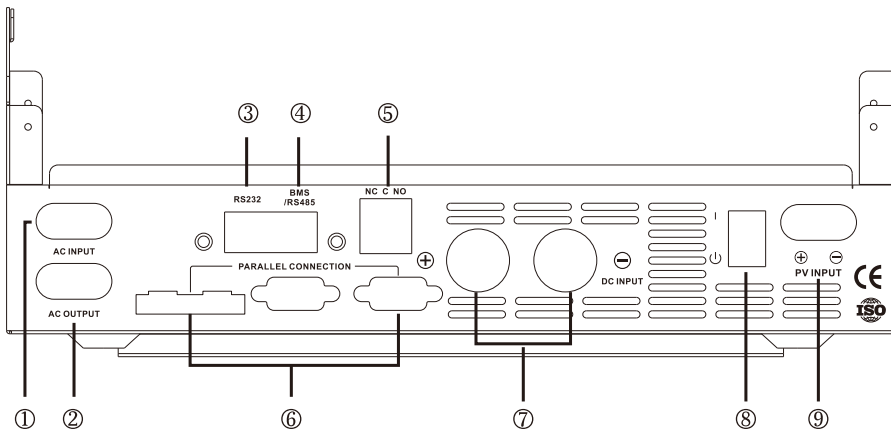

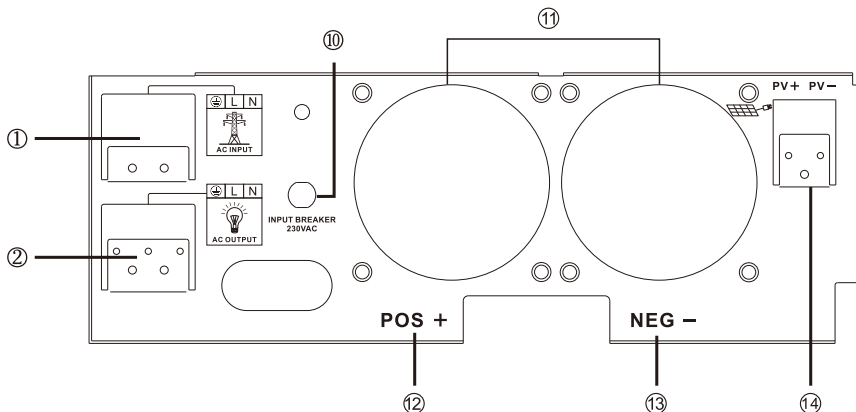

- | | |
|------------------------------------|--------------------------------|
| 1..... AC Input | 8.....Power ON/ OFF Switch |
| 2..... AC Output | 9.....PV Input |
| 3.....Communication Port | 10...Input Breaker |
| 4.....BMS/RS485 Communication Port | 11...Fan |
| 5.....Dry Contact | 12...Battery Terminal Positive |
| 6.....Parallel connection | 13...Battery Terminal Negative |
| 7.....Battery Input | 14...Solar Panel Input |

4 INSTALLATION

4.1 Unpacking and Inspection

Before installation, please inspect the unit. Be sure that nothing inside the package is damaged. You should have received the following items inside of package:

- ◆ The unit x 1
- ◆ User manual 1

4.2 Preparation

Before connecting all please take off bottom cover by removing two screws as shown below.

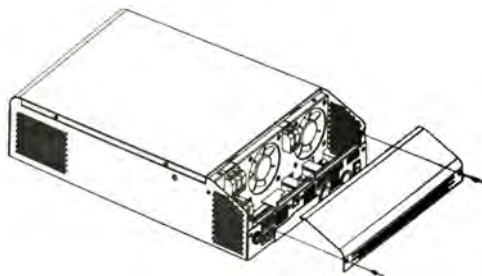

4.3 Mounting the Unit

Consider the following points before selecting where to install:

- ※ Do not mount the inverter on flammable construction materials.
- ※ Mount on a solid surface
- ※ Install this inverter at eye level in order to allow the LCD display to be read at all times.
- ※ For proper air circulation to dissipate heat, allow a clearance of approx. 20 cm to the side and approx. 50 cm above and below the unit.
- ※ The ambient temperature should be between and to ensure optimal operation.
- ※ The recommended installation position is to be adhered to the wall vertically.
- ※ Be sure to keep other objects and surfaces as shown in the diagram to guarantee sufficient heat dissipation and to have enough space for removing wires.

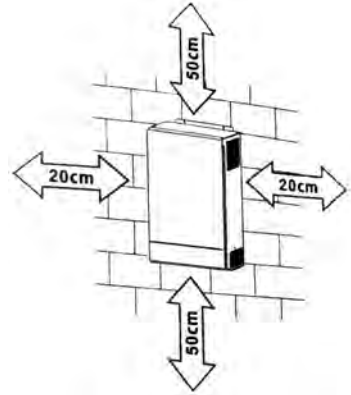

SUITABLE FOR MOUNTING ON CONCRETE OR OTHER NON-COMBUSTIBLE SURFACE ONLY.

Install the unit by screwing three screws.

- 1,2 Use the M6*80mm expansion bolts.
- 3 Use M4 or M5.



4.4 Battery Connection

CAUTION: For safety operation and regulation compliance, it's requested to install a separate DC over-current protector or disconnect device between battery and inverter. It may not be requested to have a disconnect device in some applications, however, it's still requested to over-current protection installed. Please refer to typical amperage in below table as required fuse or breaker size.

WARNING! All wiring must be performed by be qualified personnel.
WARNING! It's very important for system safety and efficient operation to use appropriate cable for battery connection. To reduce risk of injury, please use the proper recommended cable and terminal size as below.

Ring terminal:



Recommended battery cable and terminal size:

Model	Typical amperage	Battery capacity	Wire Size	Ring Terminal			Torque value
				Cabel(mm) ²	Dimensions		
					D(mm)	L(mm)	
3KVA	132A	100AH	1*4AWG	22	6.4	33.2	2~3Nm
		200AH	2*8AWG	9	6.4	29.2	
5KVA	109A	200AH	1*2AWG	38	6.4	39.2	2~3Nm
			2*6AWG	28	6.4	33.2	
8KVA	183.2A	250AH	1*2AWG	67.4	8.4	51	5Nm

please follow below steps to implement battery connection:

1. Assemble battery ring terminal based on recommended battery cable and terminal size.

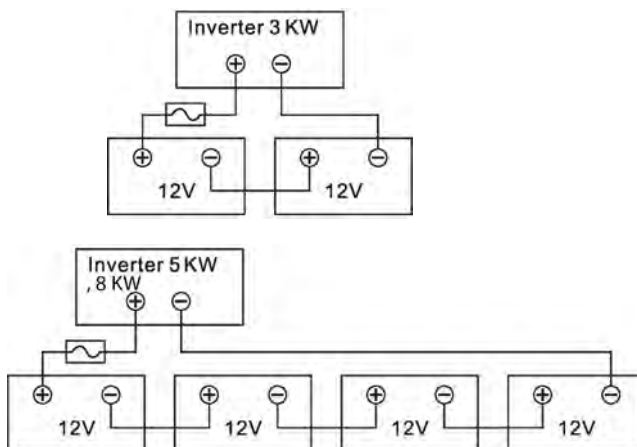

2. Insert the battery wires flatly into battery connectors of inverter and make sure the bolts are tightened with torque of 2 Nm in clockwise direction. Make sure polarity at both the battery and the inverter/charge is correctly connected and conductors are tightly screwed into the battery terminals. Recommended tool: # 2 Pozzi Screwdriver

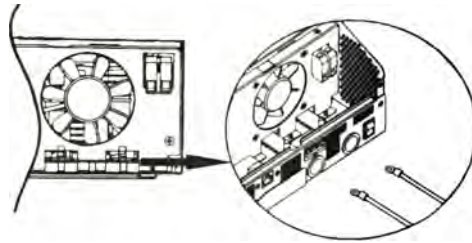

WARNING: Shock Hazard

Installation must be performed with care due to high battery voltage in series.

CAUTION!! Before making the final DC connection or closing DC breaker/disconnector, be sure positive (+) must be connected to positive(+) and negative(-) must be connected to negative (-).

4.5 AC Input Output Connection

CAUTION!! Before connecting to AC input power source, please Install a separate AC breaker between inverter and AC input power source. This will ensure the Inverter can be disconnected during maintenance and fully protected from over current of AC input. The recommended spec of breaker is 32A for 3 KW and 50A for 5 KW.

CAUTION! ! There are two terminal blocks with " IN " and " OUT " markings. Please do NOT mis-connect input and output connectors.

WARNING! All wiring must be performed by qualified personnel.

WARNING! It's very important for system safety and efficient operation to use appropriate cable for AC input connection. To reduce risk of injury, please use the proper recommended cable size as below.

Suggested cable requirement for AC wires

Model	Gauge	Torque value
3000VA	12AWG	1.2~1.6Nm
5000VA	8AWG	1.4~1.6NM
8000VA	8AWG	1.4~1.6Nm

Please follow below steps to implement AC input/ output connection

1. Before making AC input/output connection be sure to open DC protector or disconnector first.
2. Remove insulation sleeve 10mm for six conductors. And shorten phase L and neutral conductor N3 mm.

3. Insert AC input wires according to polarities indicated on terminal block and tighten the terminal screws. Be sure to connect PE protective conductor(⊕)first.

⊕→Ground(yellow-green)

L→LINE(brown or black)

N→Neutral (blue)

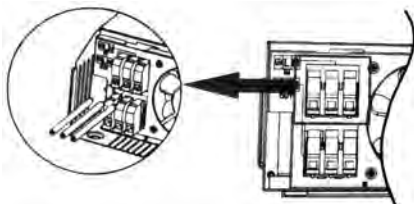

WARNING:

Be sure that AC power source is disconnected before attempting to hardwire it to the unit.

4. Make sure the wires are securely connected

CAUTION: Appliances such as air conditioner are required at least 2~3 minutes to restart because it's required to have enough time to balance refrigerant gas inside of circuits. If a power shortage occurs and recovers in a short time, it will cause damage to your connected appliances. To prevent this kind of damage, please check manufacturer of air conditioner if it's equipped with time-delay function before installation. Otherwise, this inverter/ charger will trig overload fault and cut off output to protect your appliance but sometimes it still causes internal damage to the air conditioner.

4.6 PV Connection

PV Connection(Only apply for the model with solar charger)

CAUTION:Before connecting to PV modules, please install **separately** a DC circuit breaker between inverter and PV modules.

WARNING! All wiring must be performed by a qualified personnel.

WARNING! It's very important for system safety and efficient operation to use appropriate cable for PV module connection. To reduce risk of injury, please use the proper recommended cable size as below.

Typical Amperage	Gauge	Torque Value
30A	12AWG	1.4~1.6Nm

PV module selection:

When choosing the right PV module, be sure to first consider the following requirements:

The open circuit voltage (Voc) of the PV modules does not exceed the maximum PV array open circuit voltage of the inverter. The maximum supply voltage of the PV modules should be close to the optimal PV access voltage range of the inverter for best performance. If one PV module cannot meet this requirement, it is necessary to connect multiple PV modules in series.

Model	3000VA	5000VA	8000VA
PV Charging mode	MPPT	MPPT	MPPT Dual MPPT
MAX. PV Input power	4000W	5500W	2*4000W
MPPT Tracking range	120~500Vdc	120~500Vdc	90~500Vdc
Best voltage	300~400V	300~400V	300~400V
MAX. PV Input Voltage	500Vdc	500Vdc	500Vdc
MAX. PV Charging current	100A	100A	120A
MAX. AC Charging current	60A	60A	60A
MAX. Charging current	100A	100A	120A

PV Module Wire Connection

Please follow below steps to implement PV module connection:

1. Remove insulation sleeve 10 mm for positive and negative conductors.
2. Suggest to put bootlace ferrules on the end of positive and negative wires with a proper crimping tool
3. Fix wire cover to the inverter with supplied screws as shown in below chart.

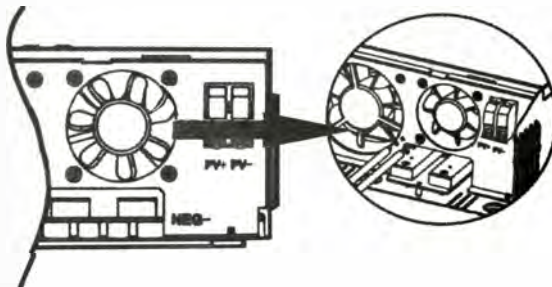
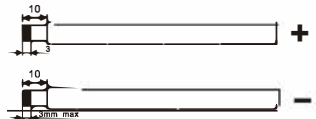

4. Check correct polarity of wire from PV modules and PV input connectors. Then, connect positive pole (+) of connection wire to positive pole (+) of PV input connector. Connect negative pole (-) of connection wire to negative pole (-) of PV input connector. Screw two wires tightly in clockwise direction. Recommended tool: 4mm blade screwdriver.

4.7 Final Assembly

After connecting all wirings, please put bottom cover back by screwing two screws as shown below.

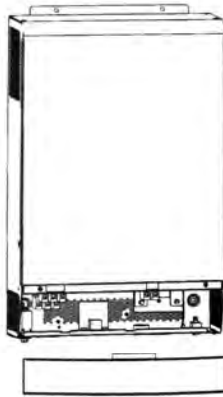

4.8 Communication Connection

1. Please use supplied communication cable to connect to inverter and PC. Insert bundled CD into a compute and follow on-screen instruction to install the monitoring software. For the detailed software operation. please check user manual of software inside of CD.

2. Wi-Fi cloud communication(option):

please use supplied communication cable to connect to inverter and Wi-Fi module. Download APP and installed from APP store, and Refer to "Wi-Fi Plug Quick Installation Guideline" to set up network and registering. The inverter status would be shown by mobile phone APP or webpage of computer.

3. GPRS cloud communication(option):

please use supplied communication cable to connect to inverter and GPRS module, and then applied external to GPRS module. Download APP and installed from APP store, and Refer to" GPRS RTU Quick Installation Guideline" to set up network and registering. The inverter status would be shown by mobile phone APP or webpage of computer.

5 OPERATION

5.1 Power ON/OFF

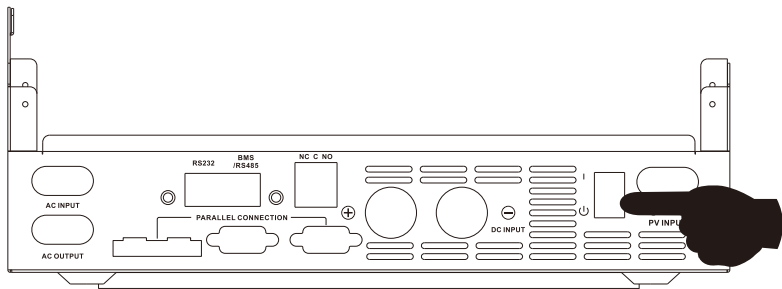

Once the unit has been properly installed and the batteries are connected well, simply press On/Off switch (located on the button of the case) to turn on the unit.

5.1.1 Steps to start up

Connect the battery that meets the requirements (battery voltage needs to beyond 23V) or AC (AC needs to confirm the suitable input range depend on the output mode), then you can start up the inverter.

➤ Mains power on

Connect to normal AC power, press the switch, the system will automatically turn on. If you set AC output power priority, after waiting for a period of time, the panel will display AC mode that represents turn on the machine successfully, then will enter the AC mode.

➤ Battery boot

Connect to battery, press the power-on button to establish a working power source.

The system will automatically turn on, after waiting for a period of time, the panel will display battery mode that represents turn on the machine successfully, then will enter the battery mode.

5.1.2 Shutdown steps

When the system is in battery mode or AC mode output, press the switch again, then the system will be turned off.

5.2 Operation and Display Panel

The operation and display panel, shown in below chart, is on the front panel of the inverter. It includes three indicators, four function keys and a LCD display, indicating the operating status and input/output power information.

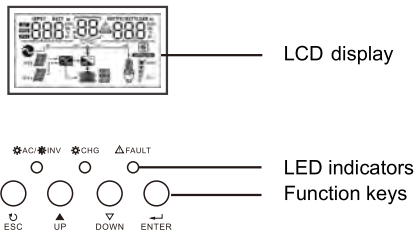

LED Indicator

LED Indicator		Messages	
	Green	Solid On	Output is powered by utility in Line mode.
		Flashing	Output is powered by battery or PV in battery mode.
	Green	Solid On	Battery is fully charged.
		Flashing	Battery is charging.
	Red	Solid On	Fault occurs in the inverter.
		Flashing	Warning condition occurs in the inverter.







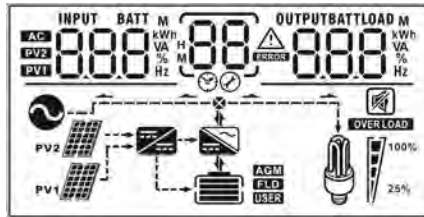



Function Keys

Function Key	Description
ESC	To exit setting mode
UP	To go to previous selection
DOWN	To go to next selection
ENTER	To confirm the selection in setting mode or enter setting mode

LCD Display Icons



Icon	Function
Input source information	
	Indicates the AC input
	Indicates the 1 st PV panel input
	Indicates the 2 nd PV panel input
Left digital display information	
	Indicate input voltage, input frequency, battery voltage, V1 voltage, PV2 voltage, charger current
Middle digital display information	
	Indicates the setting programs.
	Indicates the warning and fault codes. Warning: Flashing with warning code Fault: display with fault code
Right digital display information	
	Indicate the output voltage, output frequency, load percent, load VA, load W, PV1 charger power, PV2 charger power, DC discharging current.
Battery information	
	Indicates battery level by 0-24%, 25-49%, 50-74% and 75-100% and charging status.
	Indicates the battery type: AGM, Flooded or User-defined battery.



Load information				
		Indicates overload.		
	Indicates the load level by 0-24%,25-50%,50-74%,and 75-100%.			
	0%~25%	25%~50%	50%~75%	75%~100%
				
Mode operation information				
		Indicates unit connects to the mains.		
		Indicates unit connects to the 1 st PV panel		
		Indicates the solar charger is working		
		Indicates the DC/AC inverter circuit is working.		
Mute operation				
		Indicates unit alarm is disabled.		

Display Setting

The LCD display information will be switched in turns by pressing "UP" or "DOWN" key. The selectable information is switched as below order: input voltage, input frequency, PV voltage, charging current, battery voltage, output voltage, output frequency, load percentage, load in Watt, load in VA, load in Watt, DO discharging current, main board firmware version and SCC firmware version.

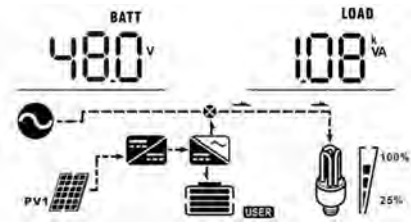
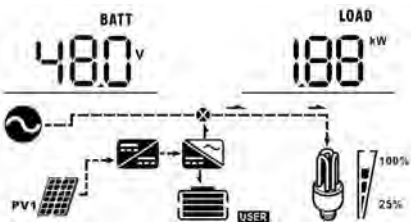
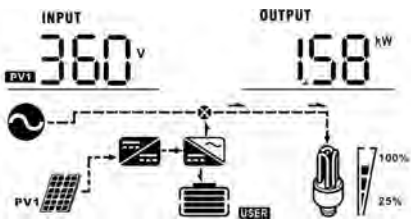
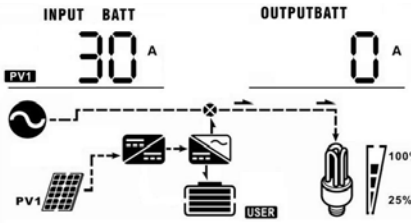
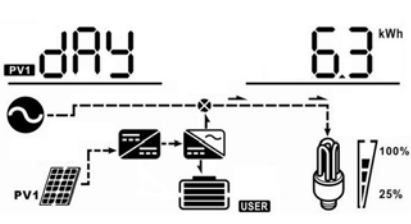

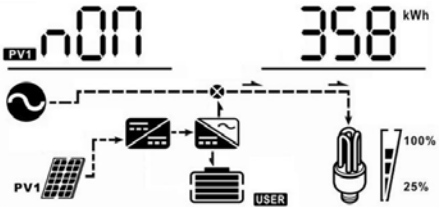
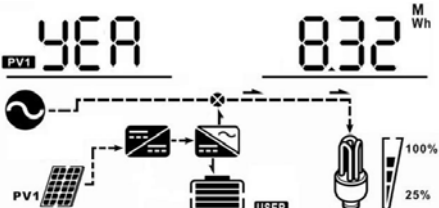
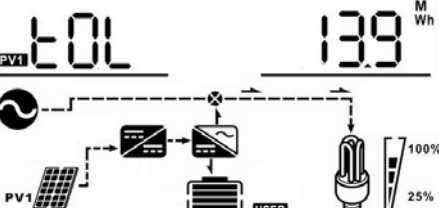
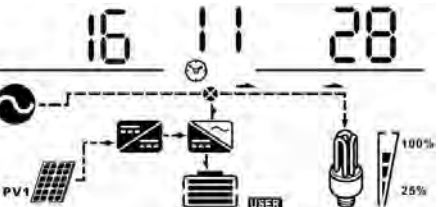

Select item	LCD display
Input voltage and output voltage (Default Display Screen)	<p>Input Voltage=230V, output voltage=230V</p>
Input frequency and output frequency	<p>Input frequency=50.0Hz, output frequency=50.0Hz</p>
Battery voltage and output voltage	<p>Battery Voltage=48.0V, output voltage=230V</p>
Battery voltage and load percentage	<p>Battery Voltage=48.0V, load percentage 68%</p>

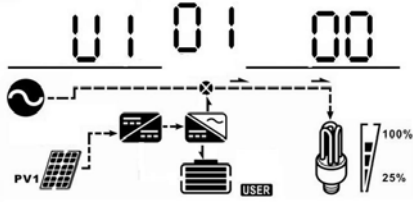
<p>Battery voltage and load in VA</p>	<p>Battery Voltage=48.0V, load in VA=1.08kVA</p> 
<p>Battery voltage and load in Watt</p>	<p>Battery Voltage=48.0V, load in Watt=1.88kW</p> 
<p>PV1 voltage and PV1 charger power</p>	<p>PV1 Voltage=360V, charging power=1.58kW</p> 
<p>Charger current and DC discharging current</p>	<p>Charging current=30A, discharging current=0A</p> 
<p>PV energy generated today</p>	<p>Today energy = 6.3kWh</p> 

<p>PV energy generated this month</p>	<p>This month energy = 358kWh.</p> 
<p>PV energy generated this year</p>	<p>This year energy = 8.32MWh</p> 
<p>PV energy generated totally</p>	<p>Total energy = 13.9MWh</p> 
<p>Real date</p>	<p>Real date Nov 28, 2016.</p> 
<p>Real time</p>	<p>Real time 13:20.</p> 

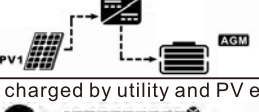
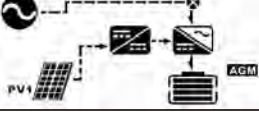
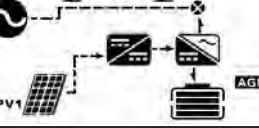
Main board firmware version	Version 00001.00 
-----------------------------	---

Operating Mode Description



Operating mode	Behaviors	LCD display
Standby mode Note: *Standby mode: The inverter is not turned on yet but at this time, the inverter can charge battery without AC output. *Power swing mode: If enabled, the output of inverter will be off when connected load is pretty low or not detected.	No output power, solar or utility charger available	Battery is charged by utility. 
		Battery is charged by PV energy. 
		Battery is charged by utility and PV energy. 
		Battery is charged by PV energy and feed PV energy grid. 
		No charging. 
Line mode	Output power from utility. Charger available	Utility charges battery and provides power to load. 
		Utility and battery power provide power to load. 

Line mode	Output power from utility. Charger available	<p>PV energy, battery power and utility provide power to load.</p>
	Output power from utility. Charger available	<p>PV energy and utility charge battery, and utility provides power to load.</p>
		<p>PV energy charges battery, utility and PV energy provide power to the load.</p>
		<p>PV energy charges battery, PV energy provides power to the load and feeds remaining energy to the grid.</p>
Battery mode	Output power from battery or PV	<p>PV energy charges battery, PV energy provides power to the load and feeds remaining energy to the grid.</p>
		<p>PV energy and battery energy supply power to the load.</p>
		<p>Battery provides power to the load.</p>
Only PV mode	Output power from PV	<p>PV provides power to the load.</p>





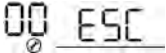
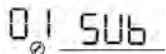
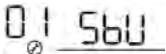
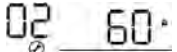
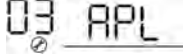
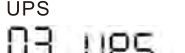

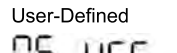



5.3 LCD Setting



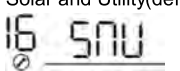

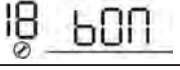
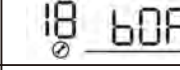
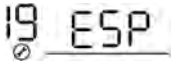
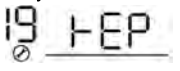

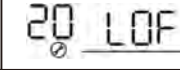
After pressing and holding ENTER button for 3 seconds, the unit will enter setting mode. Press “UP” or “DOWN” button to select setting programs. And then, press “ENTER” button to confirm the selection or ESC button exit.

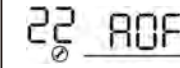
Setting Programs:

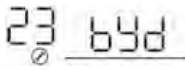
Program	Description	Selectable option	
00	Exit setting mode	Escape 	
01	Output source priority selection		Solar energy provides power to the loads as first priority. If solar energy is not sufficient to power all connected loads, Utility energy will supply power to the loads at the same time.
			Solar energy provides power to the loads as first priority. If solar energy is not sufficient to power all connected loads, battery energy will supply power to the loads at the same time. Utility provides power to the loads only when battery voltage drops to either low-level warning voltage or the setting point in program 20 or solar and battery is not sufficient.
02	Maximum charging current: To configure total charging current for solar and utility chargers. (Max. charging current = utility charging current + solar charging current)	60A(default) 	Setting range is from 10A to 100A. Increment of each click is 10A.
03	AC input voltage range	Appliances (default) 	If selected, acceptable AC input voltage range will be within 90-280VAC.
		UPS 	If selected, acceptable AC input voltage range will be within 170-280VAC.
05	Battery type	AGM (default) 	Flooded
		User-Defined 	If “User-Defined” is selected, battery charge voltage and low DC cut-off voltage can be set up in program 26, 27 and 29.

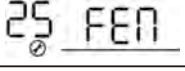
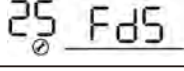

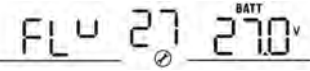
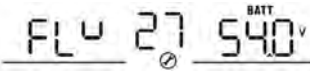

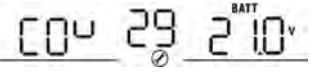
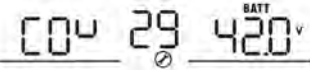



06	Auto restart when overload occurs	Restart disable(default) 06 Lfd	Restart enable 06 LfE
07	Auto restart when over temperature occurs	Restart disable (default) 07 tFd	Restart enable 07 tFE
08	ECO function: System will temporarily stop when the load is low in battery mode.	disable (default) ECO 08 SdS	
		enable ECO 08 SEE	
09	Output frequency	50Hz(default) 09 50 _{Hz}	60Hz 09 60 _{Hz}
10	Output voltage	220V 10 220 _v	230V (default) 10 230 _v
		240V 10 240 _v	
11	Maximum utility charging current Note: If setting value in program 02 is smaller than that in program in 11, the inverter will apply charging current from program 02 for utility charger.	30A(default) 11 30A	Setting range is 2A, then from 10A to 60A. Increment of each click is 10A.
12	Setting voltage point back to utility source when selecting“SBU priority” in program 01.	Available options in 3KVA model:	
		23.0V (default) 12 ^{BATT} 23.0 _v	Setting range is from 22V to 25.5V. Increment of each click is 0.5V.
		Available options in 5KVA model:	
		46V (default) 12 ^{BATT} 46 _v	Setting range is from 44V to 51V. Increment of each click is 1V.
13	Setting voltage point back to battery mode when selecting“SBU priority”in program 01.	Available options in 3KVA model:	
		Battery fully charged 13 ^{BATT} FUL	27V(default) 13 ^{BATT} 27.0 _v
		Setting range is from 24V to 29V. Increment of each click is 0.5V.	

		Available options in 5KVA model:	
		Battery fully charged	54V (default)
			
		Setting range is from 48V to 58V. Increment of each click is 1V.	
16	Charger source priorit: To configure charger source priority	If this inverter/charger is working in Line, Standby or Fault mode, charger source can be programmed as below:	
		Utility first 	Utility will charge battery as first priority. Solar energy will charge battery only when utility power is not available.
		Solar first 	Solar energy will charge battery as first priority. Utility will charge battery only when solar energy is not available.
		Solar and Utility(default) 	Solar energy and utility will charge battery at the same time.
		Only Solar 	Solar energy will be the only charger source no matter utility is available or not.
		If this inverter/charger is working in Battery mode, only solar energy can charge battery. Solar energy will charge battery if it's available and sufficient.	
18	Alarm control	Alarm on (default) 	Alarm off 
19	Auto return to default display screen	Return to default display screen (default) 	If selected, no matter how users switch display screen, it wil automatically return to defaultl display screen (Input voltage /output voltage) after no button is pressed for 1 minute.
		Stay at latest screen 	If selected, the display screen will stay at latest screen user finally switches.
20	Backlight control	Backlight on (default) 	Backlight off 
22	Beeps while primary source is interrupted	Alarm on (default) 	Alarm off 

23	Overload bypass: When enabled, the unit will transfer to line mode if overload occurs in battery mode.	Bypass disable (default) 	Bypass enable 
25	Record Fault code	Record enable (default) 	Record disable 
26	Bulk charging voltage (C.V voltage)	3KVA default setting: 28.2V 	
		5KVA default setting: 56.4V 	
		If self-defined is selected in program 5, this program can be set up. Setting range is from 25.0V to 31.5V for 3KVA model and 48.0V to 61.0V for 5KVA model. Increment of each click is 0.1V.	
27	Floating charging voltage	3KVA default setting: 27.0V 	
		5KVA default setting: 54.0V 	
28	Reset factory setting	default: 	
			
29	Low DC cut-off voltage: <ul style="list-style-type: none"> If battery power is only power source available inverter will shut down. If PV energy and battery power are available, inverter will charge battery without AC output. 	If self-defined is selected in program 5, this program can be set up. Setting range is from 21.0V to 24.0V for 3KVA model and 42.0V to 48.0V for 5KVA model. Increment of each click is 0.1V. Low DC cut-off voltage will be fixed to setting value no matter what percentage of load is connected. 	
		5KVA default setting: 42.0V 	

30	Battery equalization	Battery equalization 30 EEN	Battery equalization disable (default) 30 EdS
		If "Flooded" or "User Defined" is selected in program 05, this program can be set up.	
31	Battery equalization voltage	3KVA default setting: 29.2V EV 31 29.2 ^{BATT} v	5KVA default setting: 58.4V EV 31 58.4 ^{BATT} v
		Setting range is from 25.0V to 31.5V for 3KVA mode and 48.0V to 61.0 V for 5KVA model. Increment of each click is 0.1V.	
33	Battery equalized time	60min (default) 33 60	Setting range is from 5min to 900min. Increment of each click is 5min.
34	Battery equalized timeout	120min (default) 34 120	Setting range is from 5min to 900min. Increment of each click is 5min.
35	Equalization interval	30days (default) 35 30d	Setting range is from 0 to 90 days. Increment of each click is 1 day.
36	Equalization activated immediately	Enable 36 AEN	Disable (default) 36 AdS
		If equalization function is enabled in program 30, this program can be set up. If "Enable" is selected in this program, it's to activate battery equalization immediately and LCD main page will show " E9 ", If "Disable" is selected, it will cancel equalization function until next activated equalization time arrives based on program 35 setting. At this time, " E9 " will not be shown in LCD main page.	

37	BMS Function Switch	off(default) bns 37 OFF	Whether to enable the BMS communication function
		bns 37 ON	
38	Bat Soc Under Lock	bSU 38 ^{BATT} 10%	BMS low voltage SOC value, if the BMS SOC value is lower than the set value, the inverter will shut down to protect the battery.
39	Bat Soc Turn To Ac	StC 39 ^{BATT} 20%	When the working mode of the inverter is set to the battery priority mode, the inverter will be forced to enter the mains charging when the SOC of the BMS is lower than the set value.
40	Bat Soc Turn To Dc	Stb 40 ^{BATT} 95%	When the working mode of the inverter is set to the battery priority mode, the inverter resumes the DC working mode when the SOC of the BMS is higher than the set value.
41	Bat Restart Soc	bSt 41 ^{BATT} 50%	When the inverter is turned on, the SOC must be higher than the set value to work normally.
43	Solar supply priority	43 <u>BLU</u>	Solar energy provides power to charge battery as first priority.
		43 <u>LBU</u>	Solar energy provides power to the loads as first priority.
44	Solar or battery energy feed to grid configuration	44 <u>GTd</u>	Solar or battery energy feed to grid disable.
		44 <u>GTe</u>	Solar or battery energy feed to grid enable.
45	Reset PV energy storage	Notre set (Default)	Reset
		45 <u>nrE</u>	45 <u>rSt</u>
46	Start charging time for AC charger	00:00(Default)	
		46 ^{BATT} 000 ^h	The setting range of start charging time for AC charger is from 00:00 to 23:00, increment of each click is 1 hour.

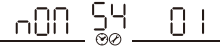
47	Stop charging time for AC charger	<p>00: 00(Default)</p>  <p>The setting range of scheduled Time for AC output on is from 00: 00 to 23:00, increment of each click is 1 hour.</p>	
48	Scheduled time for AC output on	<p>00: 00(Default)</p>  <p>The setting range of scheduled Time for AC output off is from 00: 00 to 23:00, increment of each click is 1 hour.</p>	
49	Scheduled time for AC output off	<p>00: 00(Default)</p>  <p>The setting range of scheduled Time for AC output off is from 00: 00 to 23:00, increment of each click is 1 hour.</p>	
50	Set country customized regulations	<p>India(Default)</p> 	<p>If selected, acceptable feed-in grid voltage range will be 195.5~253VAC. Acceptable feed-in grid frequency range will be 49~51Hz.</p>
		<p>Germany</p> 	<p>If selected, acceptable feed-in grid voltage range will be 184~264.5VAC. Acceptable feed-in grid frequency range will be 47.5~51.5Hz.</p>
		<p>South America</p> 	<p>If selected, acceptable feed-in grid voltage range will be 184~264.5VAC. Acceptable feed-in grid frequency range will be 57~62Hz.</p>
51	Time setting-Minute	 <p>For minute setting, the range is from 00 to 59.</p>	
52	Time setting-Hour	 <p>For hour setting, the range is from 00 to 23.</p>	
53	Time setting-Day	 <p>For day setting, the range is from 00 to 31.</p>	
54	Time setting-Month	 <p>For year setting, the range is from 16 to 99.</p>	

55	Time setting-Year	 For year setting, the range is from 16 to 55.
----	-------------------	--

When the BMS/485 communication interface is externally connected, as shown in the following figure:

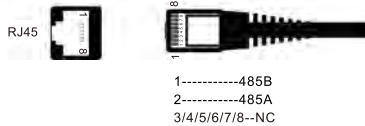

5.4 Battery Equalization Description

Equalization function is added into charge controller, It reverses the buildup of negative chemical effects like stratification, a condition where acid concentration is greater at the bottom of the battery than at the top. Equalization also helps to remove sulfate crystals that might have built up on the plates. If left unchecked, this condition, called sulfation, will reduce the overall capacity of the battery. Therefore, it's recommended to equalize battery periodically.

※ How to Apply Equalization Function

You must enable battery equalization function in monitoring LCD setting program 30 first. Then, you may apply this function in device by either one of following methods:

- 1.Setting equalization interval in program 35.
- 2.Active equalization immediately in program 36.

※ **When to Equalize**

In stage, when the setting equalization interval(battery equalization cycle) is arrived, or equalization is active immediately, the controller will start to enter Equalize stage.

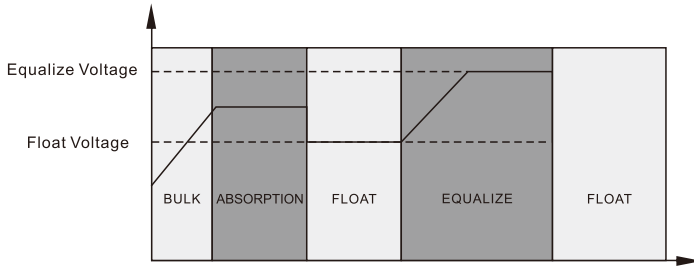

※ **Equalize charging time and timeout**

In Equalize stage, the controller will supply power to charge battery as much as possible until battery voltage raises to battery equalization voltage. Then, constant-voltage regulation is applied to maintain battery voltage at the battery equalization voltage. The battery will remain in the Equalize stage until setting battery equalized time is arrived.

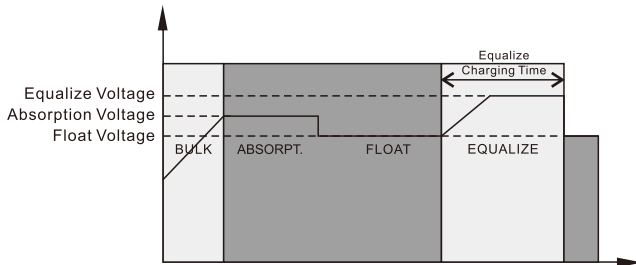

However, in Equalize stage, when battery equalized time is expired and battery voltage doesn't rise to battery equalization voltage point, the charge controller will extend the battery equalized time until battery voltage achieves battery equalization voltage. If battery voltage is still lower than battery equalization voltage when battery equalized timeout setting is over, the charge controller will stop equalization and return to float stage.

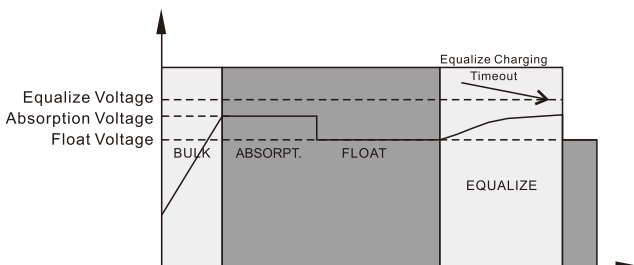

















5.5 Function and alarm description

5.5.1 Faults Descriptions

➤ **Fault:** The inverter enters the fault mode, the red LED light is always on and the LCD displays the fault code.

Fault Reference Code

Fault Code	Fault Event	Icon on
01	Fan is locked when inverter is off.	
02	Over temperature or NTC is not connected well.	
03	Battery voltage is too high.	
04	Battery voltage is too low.	
05	Output short circuited or over temperature is detected by internal converter components.	
06	Output voltage is too high.	
07	Over load time out.	
08	Bus voltage is too high	
09	Bus soft start failed	
51	Over currents or surge	
52	Bus voltage is too low	
53	Inverter soft start failed	
55	Over DC voltage in AC output	
57	Current sensor failed	
58	Output voltage is too low	
59	PV voltage is over limitation	

5.5.2 Warning Descriptions

➤ **Alarm:** The red LED flashes, and the LCD displays an alarm code, the inverter does not enter the failure mode

Warning Indicator

Warning Code	Warning Event	Audible Alarm	Icon flashing
01	Fan is locked when inverter is on.	Beep three times every second	
02	Over temperature	None	
03	Battery is over-charged	Beep once every second	
04	Low battery	Beep once every second	
07	Overload	Beep once every 0.5 second	
10	Output power derating	Beep twice every 3 seconds	
15	PV energy is low.	Beep twice every 3 seconds	
16	High AC input (>280VAC) during BUS soft start	None	
E9	Battery equalization	None	
bP	Battery is not connected	None	

5.5.3 Code Reference

Related information code will be displayed on LCD screen. Please check inverter LCD screen for the operation.

Code	Description
60	If battery status is not allowed to charge and discharge after the communication between the inverter and battery is successful, it will show code 60 to stop charging and discharging battery.
61	Communication lost <ul style="list-style-type: none"> After battery is connected, communication signal is not detected for 3 minutes, buzzer will beep. After 10 minutes, inverter will stop charging and discharging to lithium battery. Communication lost occurs after the inverter and battery is connected successfully, buzzer beeps immediately.
69	If battery status is not allowed to charge after the communication between the inverter and battery is successful, it will show code 69 to stop charging battery.
70	If battery status must to charge after the communication between the inverter and battery is successful, it will show code 70 to charge battery.
71	If battery status is not allowed to discharge after the communication between the inverter and battery is successful, it will show code 71 to stop discharge battery.

6. Trouble removal

Problem	LCD/LED/Buzzer	Explanation/Possible cause	What to do
Unit shuts down automatically during startup process.	LCD/LEDs and buzzer will be active for 3 seconds and then complete off.	The battery voltage is too low (<1.91V/Cell)	1. Re-charge battery. 2. Replace battery.
No response after power on.	No indication	1. The battery voltage is far too low.(<1.4V/Cell) 2. Internal fuse tripped.	1.Contact repair center for replacing the fuse. 2. Re-charge battery. 3. Replace battery.
Mains exist but the unit works in battery mode.	Input voltage is displayed as 0 on the LCD and green LED is flashing.	Input protector is tripped	Check if AC breaker is tripped and AC wiring is connected well.
	Green LED is flashing	Insufficient quality of AC power. (Shore or Generator)	1. Check if AC wires are too thin and/or too long. 2. Check if generator (if applied)is working well or if input voltage range setting is correct.(UP-->sppliance)
	Green LED is flashing.	Set "Solar First" as the priority of output source.	Change output source priority to Utility first.
When the unit is turned on, internal relay is switched on and off repeatedly.	LCD display and LEDs are flashing	Battery is disconnected.	Check if battery wires are connected well.
Buzzer beeps continuously and red LED is on.	Fault code 07	Overload error. The inverter is overload 105% and time is up.	Reduce the connected load by switching off some equipment.
		If PV input voltage is higher than specification, the output power will be derated.At this time, if connected loads is higher than derated output power, it will cause overload.	Reduce the number of PV modules in series or the connected load.
	Fault code 05	Output short circuited.	Check if wiring is connected well and remove abnormal load.
		Temperature internal converter component is over 120°C.	Check whether the air flow of the unit is blocked or whether the ambient temperature is too high.
	Fault code 02	Internal temperature of inverter component is over 100°C	
	Fault code 03	Battery is over-charged	Return to repair center.
		The battery voltage is too high.	Check if spec and quantity of batteries are meet requirements.
	Fault code 01	Fan fault	Replace the fan.
	Fault code 06/58	Output abnormal (Inverter voltage below than 190Vac or is higher than 260Vac)	1. Reduce the connected load. 2. Return to repair center
	Fault code 08/09/53/57	Internal components failed.	Return to repair center.
	Fault code 51	Over current or surge.	Restart the unit, if the error happens again, please return to repair center.
	Fault code 52	Bus voltage is too low.	
Fault code 55	Output voltage is unbalanced.		
Fault code 59	PV input voltage is beyond the specification.	Reduce the number of PV modules in series.	

7. Technical datasheet

Model		3000VA	5000VA	8000VA
Input	Input Sources	L+N+PE		
	Rated Input Voltage	220/230/240VAC		
	Voltage Range	90-280VAC±3V(APL Mode)170-280VAC±3V(UPS Mode)		
	Frequency	50Hz/60Hz(Auto Adaptive)		
Output	Rated Capacity	3000W	5000W	8000W
	Output Voltage	220/230/240VAC±5%		
	Output Frequency	50/60Hz±0.1%		
	Waveform	Pure Sine Wave		
	Transfer Time (adjustable)	Computers(UPS Mode)10ms, Appliance(APL Mode)20ms		
	Peak Power	6000VA	10000VA	16000VA
	Over Load Ability	Battery Mode: 21s@105%-150%Load 11s@150%-200%Load 400ms@>200%Load		
	Peak Efficiency (battery Mode)	>94%	>94%	>98%
Battery	Battery Voltage	24Vdc	48Vdc	48Vdc
	Constant Charging Voltage(Adjustable)	28.2Vdc	56.4Vdc	56.4Vdc
	Floate Charging Voltage(Adjustable)	27Vdc	54Vdc	54Vdc
	Chargers	PV Charging Mode	MPPT	MPPT
MAX.PV Input Power		1500W	5500W	2*4000W
MPPT Tracking Range		30~145Vdc	120~500Vdc	90~500Vdc
Best voltage		30~115V	300~400V	300~400V
MAX.PV Input Voltage		150Vdc	500Vdc	500Vdc
MAX.PV Charging Current		60A	100A	120A
MAX.AC Charging Current		60A	60A	60A
MAX.Charging Current		120A	100A	120A
Display		LCD Display	Display Running Mode/Loads/Input/Output etc.	
	Interface	RS232	Baud Rate2400	
Communication Port		Lithium Battery BMS Communication Card WifiCard, Dry Contact		
Parallel Connect Interface		Without Parallel connect	With Parallel	
Environments	Operating Temperature	-10~50℃		
	Humidity	20%~95%(Non-condensing)		
	Storage Temperature	-15~60℃		
	Altitude	Altitude Not Over 1000m,Derating over 1000m,Max 4000m, Refer to IEC62040		
	Noise	≤50db		

Appendix I: Parallel function

1. Introduction

This inverter can be used in parallel with two different operation modes.

1. Parallel operation in single phase with up to 9 units. The supported maximum output power for 2KW is 18KW/18KVA, for 3KW is 27KW/27KVA and for 5KW is 45KW/45KVA.
2. Maximum nine units work together to support three-phase equipment. Seven units support one phase maximum. For 2KW, the supported maximum output power is 18 KW/18KVA and one phase can be up to 14KW/14 KVA. For 3KW, the supported maximum output power is 27KW/27KVA and one phase can be up to 21KW/21KVA. For 5KW, the supported maximum output power is 45KW/45KVA and one phase can be up to 35KW/35KVA.

NOTE: If this unit is bundled with share current cable and parallel cable, this inverter is default supported parallel operation. You may skip section 3. If not, please purchase parallel kit and install this unit by following instruction from professional technical personnel in local dealer.

2. Package Contents

In parallel kit, you will find the following items in the package:

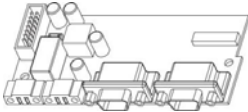

Parallel board



Parallel communication I cable



Current sharing cable

3. Parallel board installation

Step 1: Remove wire cover by unscrewing all screws.

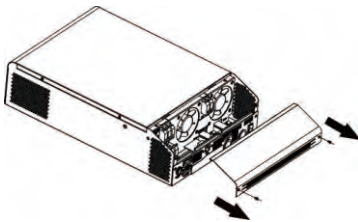

Step 2: Remove communication board by unscrewing two screws as below chart

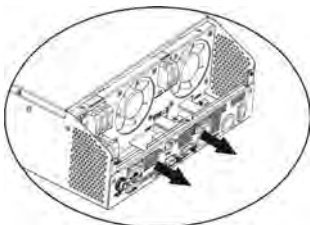

Step 3: Remove two screws as below chart and remove 2-pin and 14-pin cables. Take out the board under the communication board.

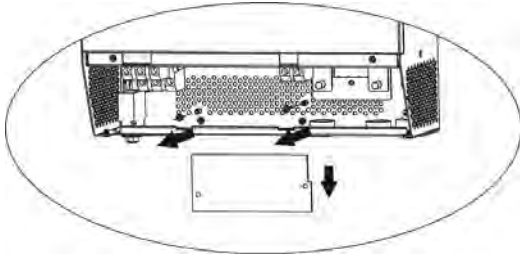

Step 4: Remove two screws as below chart to take out cover of parallel communication.

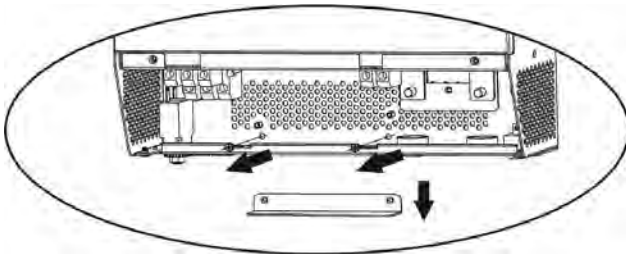

Step 5: Install new parallel board with 2 screws tightly.

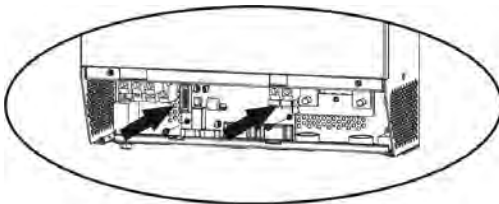

Step 6: Re-connect 2-pin and 14-pin to original position.

Parallel board

Communication board

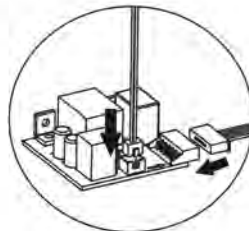
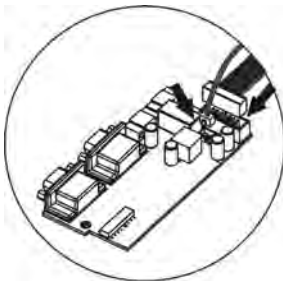

Step7: Put communication board back to the unit.

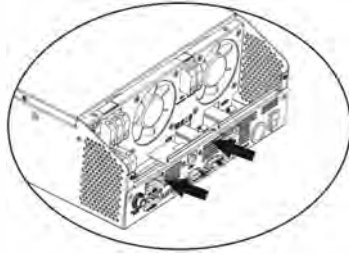

Step8: Put wire cover back to the unit. Now the inverter is providing parallel operation function.

4. Mounting the Unit

When installing multiple units, please follow below chart.

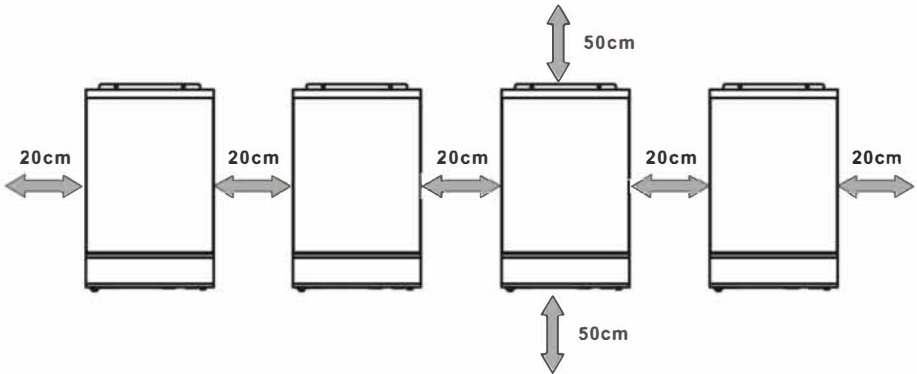

NOTE: For proper air circulation to dissipate heat, allow a clearance of approx. 20 cm to the side and approx.50 cm above and below the unit, Be sure to install each unit in the same level.

5. Wiring Connection

NOTICE: It's requested to connect to battery for parallel operation.

The cable size of each inverter is shown as below:

Recommended battery cable and terminal size for each inverter:

Model	Wire Size	Ring Terminal			Torque value
		Cable mm ²	Dimensions		
			D (mm)	L (mm)	
3000VA	1*4AWG	22	6.4	33.2	2~ 3Nm
5000VA	1*2AWG	38	6.4	33.2	2~ 3Nm

Ring terminal:

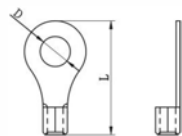

WARNING: Be sure the length of all battery cables is the same. Otherwise, there will be voltage difference between inverter and battery to cause parallel inverters not working.

Recommended AC input and output cable size for each inverter:

Model	AWG no.	Torque
3000VA	12 AWG	1.2~ 1.6Nm
5000VA	10 AWG	1.2~1.6Nm

You need to connect the cables of each inverter together. Take the battery cables for example: You need to use a connector or bus-bar as a joint to connect the battery cables together, and then connect to the battery terminal. The cable size used from joint to battery should be X times cable size in the tables above. indicates the number of inverters connected in parallel.

Regarding AC input and output, please also follow the same principle.

WARNING!! Make sure all output N wires of each inverter must be connected all the time. Otherwise, it will cause inverter fault in error code #72.

CAUTION!! Please install the breaker at the battery and AC input side. This will ensure the inverter can be securely disconnected during maintenance and fully protected from over current of battery or AC input. The recommended mounted location of the breakers is shown in the figures in 5- 1 and 5-2.

Recommended breaker specification of battery for each inverter:

Model	1 unit*
3000VA	80A/70VDC
5000VA	125A/70VDC

*If you want to use only one breaker at the battery side for the whole system, the rating of the breaker should be X times current of 1 unit." X " indicates the number of inverters connected in parallel.

Recommended breaker specification of AC input with single phase:

Model	2 units	3 units	4 units	5 units	6 units	7 units	8 units	9 units
3000VA	80A/ 230VAC	120A/ 230VAC	160A/ 230VAC	200A/ 230VAC	240A/ 230VAC	280A/ 230VAC	320A/ 230VAC	360A/ 230VAC
5000VA	80A/ 230VAC	120A/ 230VAC	160A/ 230VAC	200A/ 230VAC	240A/ 230VAC	280A/ 230VAC	320A/ 230VAC	360A/ 230VAC

Note1: Also, you can use 40A breaker for 2KW and 50A for 3KW/5KW for only 1 unit and install one breaker at its AC input in each inverter.

Note2: Regarding three-phase system, you can use 4-pole breaker directly and the rating of the breaker should be compatible with the phase current limitation from the phase with maximum units

Recommended battery capacity

Inverter parallel numbers	2	3	4	5	6	7	8	9
Battery Capacity for 3000VA	400AH	600AH	800AH	1000AH	1200AH	1400AH	1600AH	1800AH
Battery Capacity for 5000VA	400AH	600AH	800AH	1000AH	1200AH	1400AH	1600AH	1800AH

WARNING! Be sure that all inverters will share the same battery bank . Otherwise, the inverters will transfer to fault mode.

5-1. Parallel Operation in Single phase

Two inverters in parallel:

Power Connection

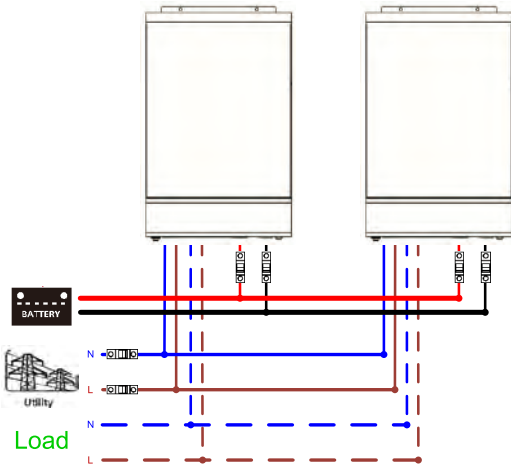

Communication Connection

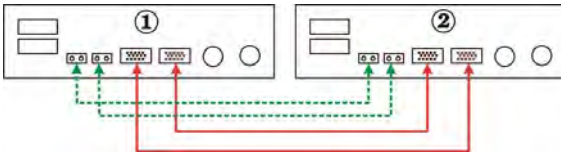

Three inverters in parallel:

Power Connection

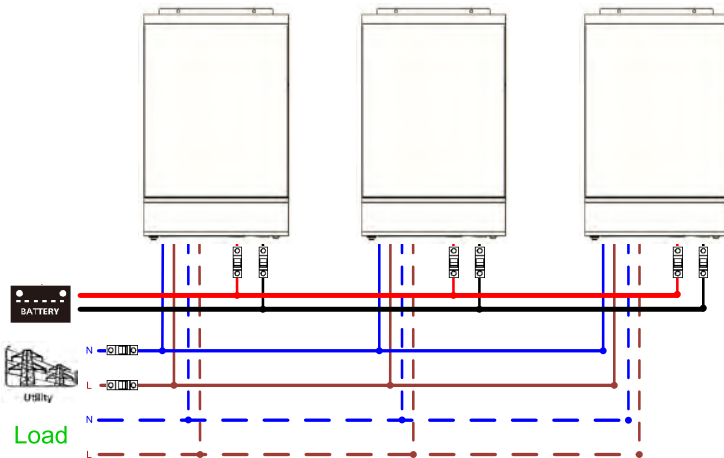

Communication Connection

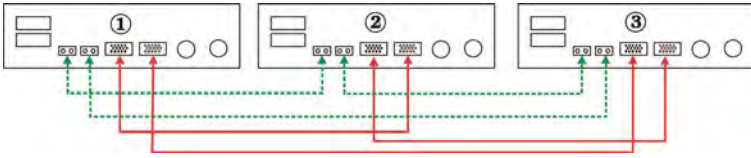

Four inverters in parallel:

Power Connection

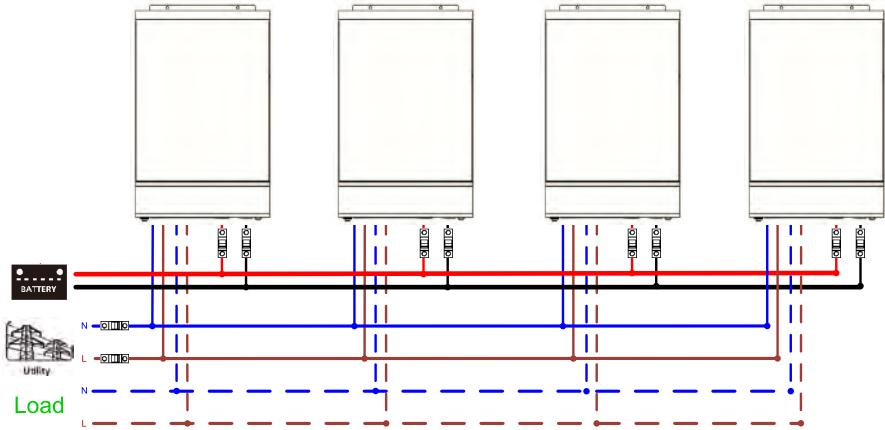

Communication Connection

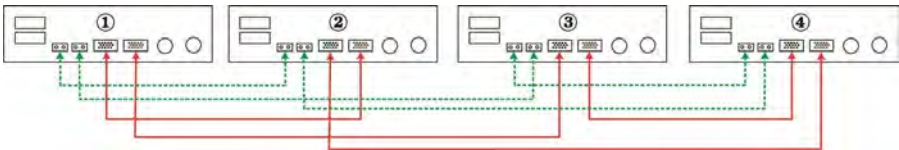

Five inverters in parallel:

Power Connection

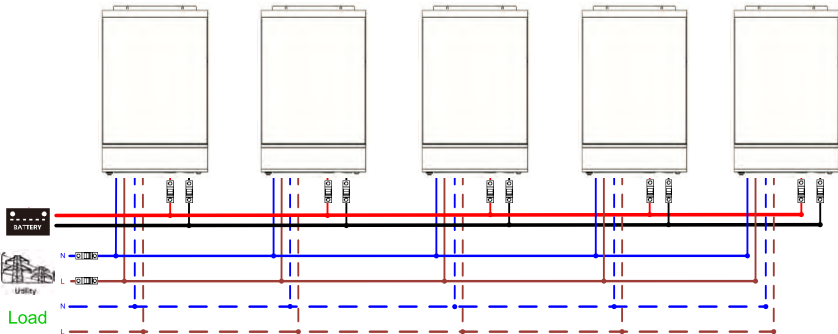

Communication Connection

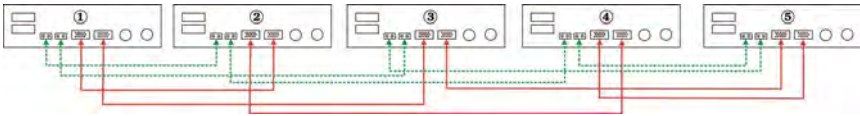

Six inverters in parallel:

Power Connection

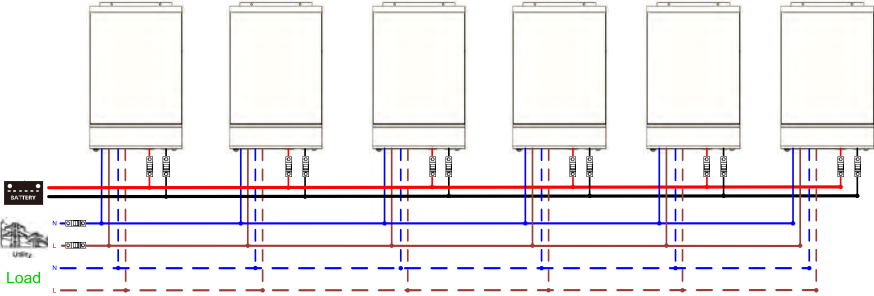

Communication Connection

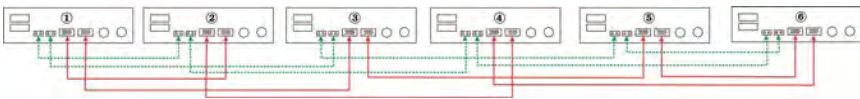

Seven to nine inverters in parallel:

Power Connection

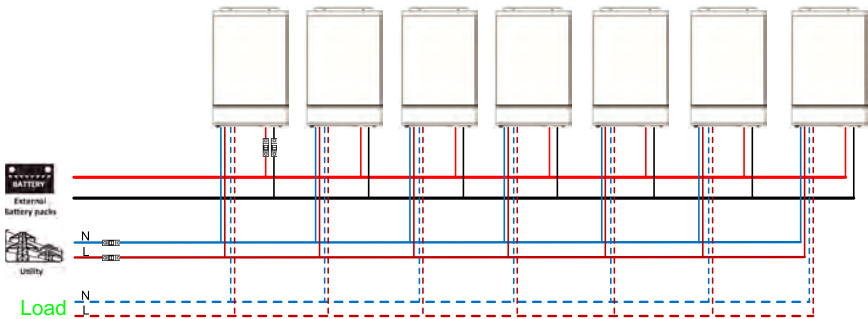

Communication Connection

🕒 Seven inverters in parallel



⌚ Eight inverters in parallel



⌚ Nine inverters in parallel

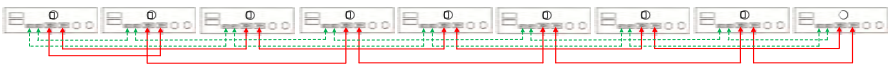

5-2. Support 3-phase equipment

Three inverters in each phase:

Power Connection

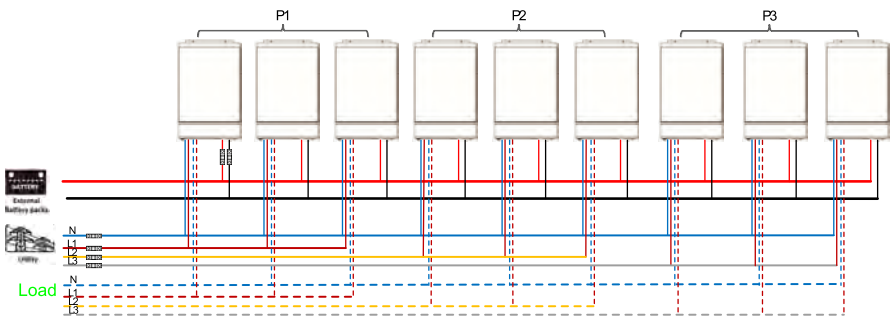

Communication Connection



Three inverters in one phase, three inverters in second phase and two inverter for the third phase:

Power Connection

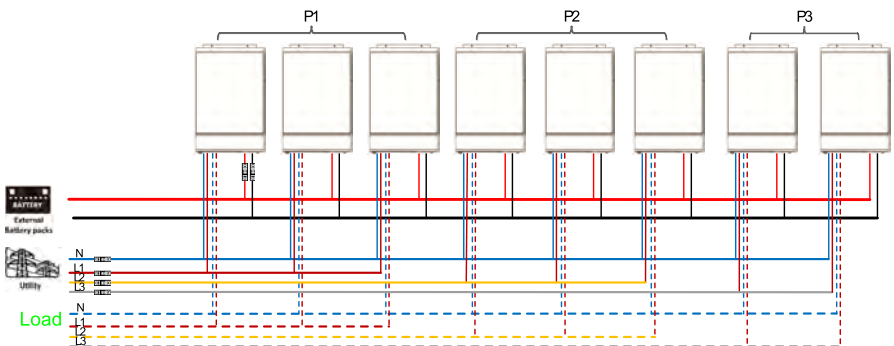

Communication Connection



Three inverters in one phase, two inverters in second phase and two inverters for the third phase:

Power Connection

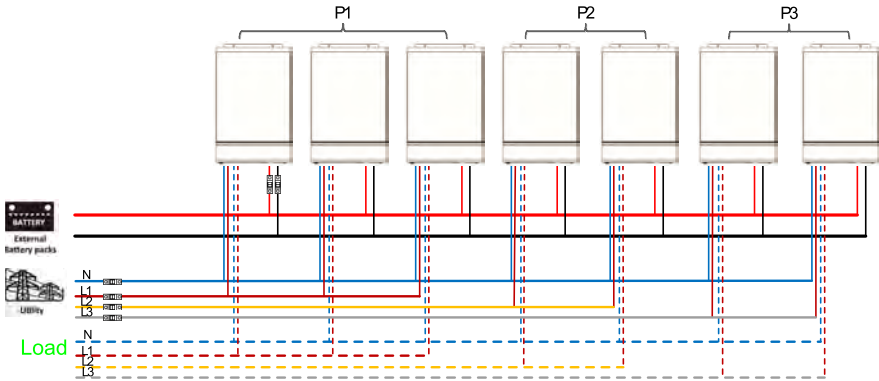

Communication Connection



Two inverters in each phase:

Power Connection

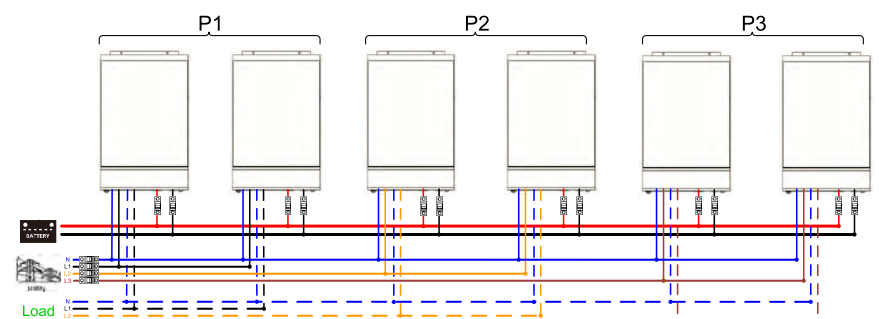

Communication Connection

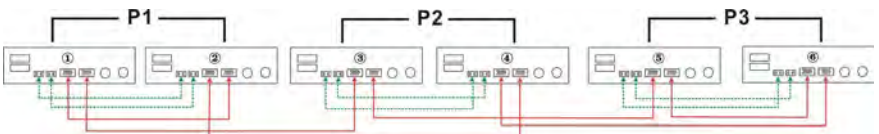

Four inverters in one phase and one inverter for the other two phases:

Power Connection

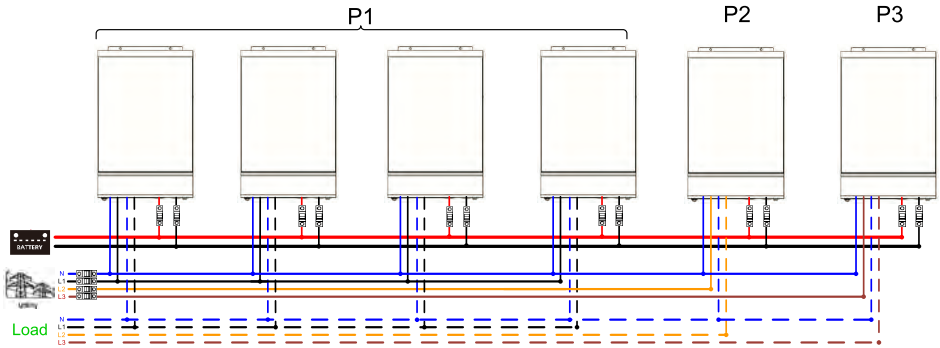

Communication Connection

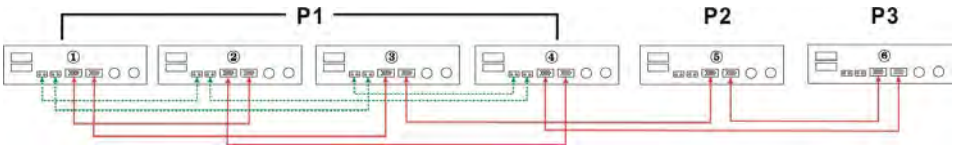

Three inverters in one phase, two inverters in second phase and one inverter for the third phase:

Power Connection

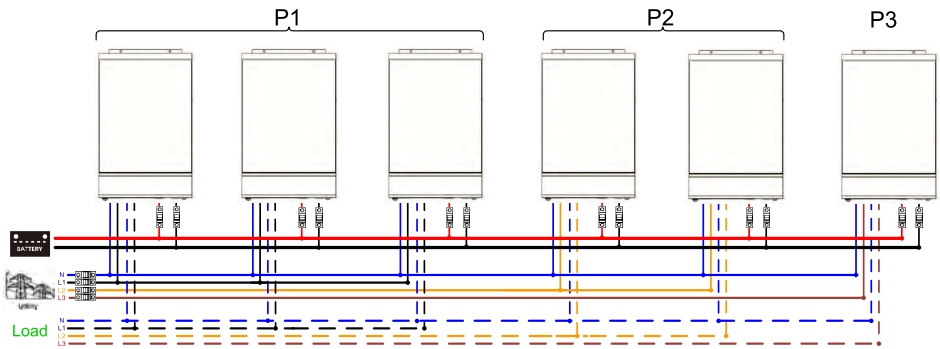

Communication Connection

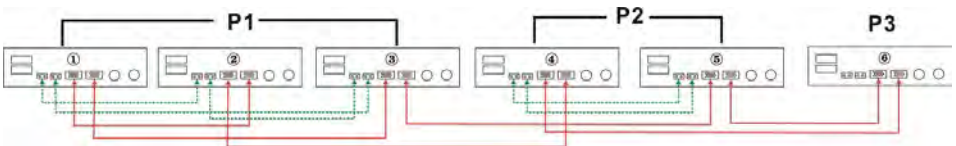

Three inverters in one phase and only one inverter for the remaining two phases:

Power Connection

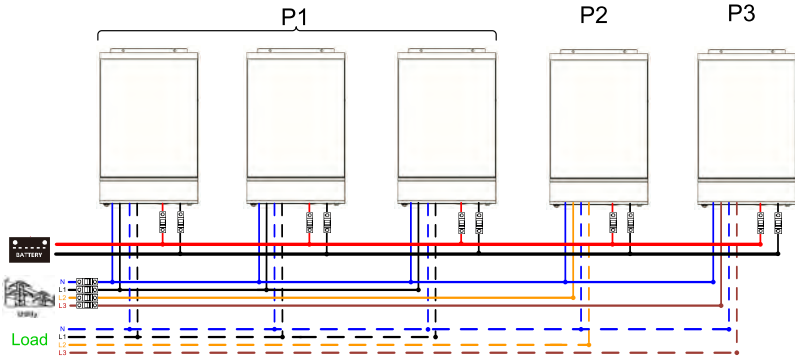

Communication Connection

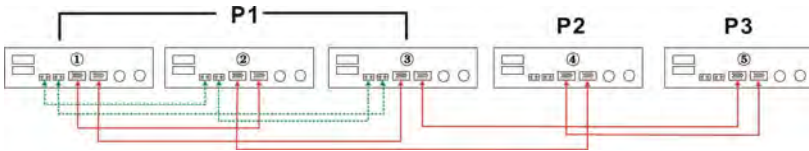

Two inverters in two phases and only one inverter for the remaining phase:

Power Connection

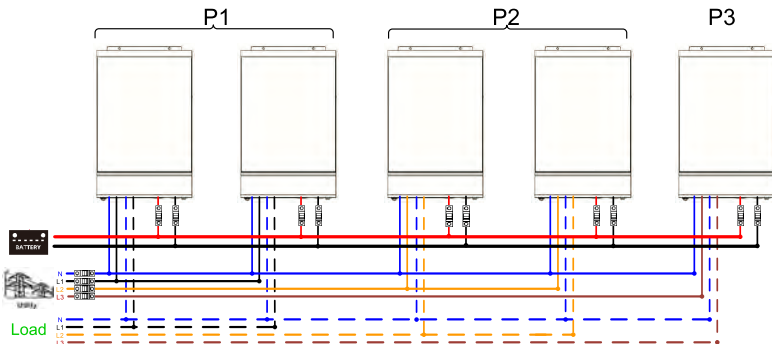

Communication Connection

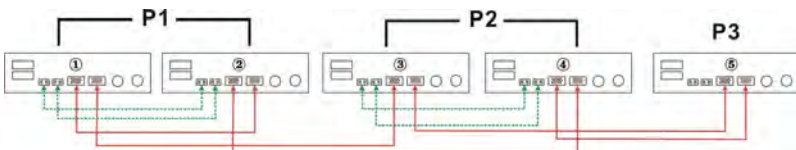

Two inverters in one phase and only one inverter for the remaining phases:
Power Connection

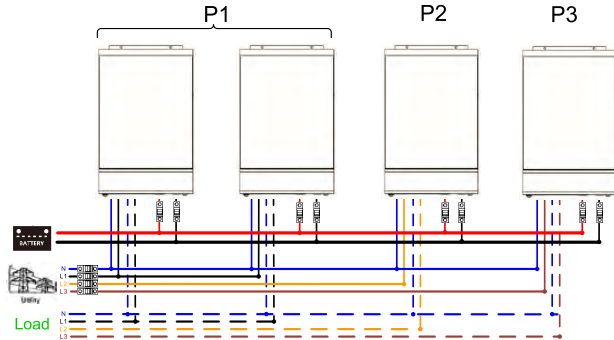

Communication Connection



One inverter in each phase:
Power Connection

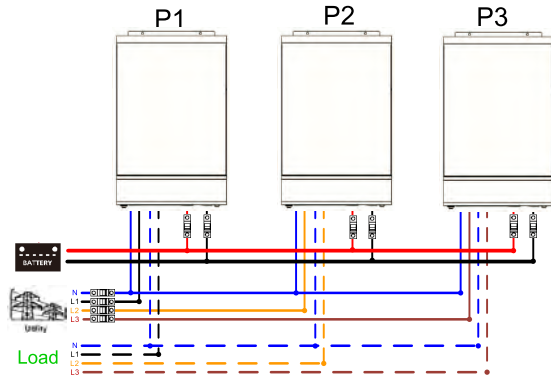

Communication Connection

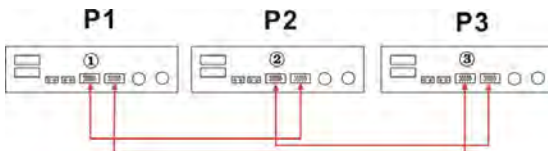

WARNING: Do not connect the current sharing cable between the inverters which are in different phases. Otherwise, it may damage the inverters.

6. PV Connection

Please refer to user manual of single unit for PV Connection
CAUTION: Each inverter should connect to PV modules separately.

7.LCD Setting and Display

Setting Program:

Program	Description	Selectable option	
04	AC output mode *This setting is only available when the inverter is in standby mode (Switch off).	Single: 	When the units are used in parallel with single phase, please select "PAL" in program 4.
		Parallel: 	
		L1 phase: 	It is required to have at least 3 inverters or maximum 6 inverters to support three-phase equipment. It's required to have at least one inverter in each phase or it's up to four inverters in one phase please-2 for detailed information. Please select "3P1" in program 4 for the inverters connected to phase, "3P2" in program 4 for the inverters connected to L2 phase and "3P3" in program 4 for the inverters connected to L3 phase.
		L2 phase: 	
		L3 phase: 	
		Be sure to connect share current cable to units which are on the same phase. Do NOT connect share current cable between units on different phases.	
		Besides, power saving function will be automatically disabled.	

Fault code display

Fault Code	Fault Event	Icon on
60	Power feedback protection	
71	Firmware version inconsistent	
72	Current sharing fault	
80	CAN fault	
81	Host loss	
82	Synchronization loss	
83	Battery voltage detected different	
84	AC input voltage and frequency detected different	
85	AC output current unbalance	
86	AC output mode setting is different	

8. Commissioning

Parallel in single phase

Step 1: Check the following requirements before commissioning:

- ⌘ Correct wire connection
- ⌘ Ensure all breakers in Line wires of load side are open and each Neutral wires of each unit are connected together.

Step 2: Turn on each unit and set "PAL" in LCD setting program 4 of each unit. And then shut down all units.

NOET: It's necessary to turn off switch when setting LCD program. Otherwise, the setting can not be programmed.

Step 3: Turn on each unit.

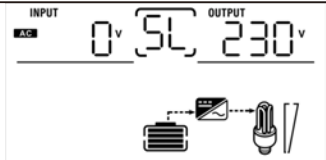
LCD display in Master unit	LCD display in Slave unit
	

NOTE: Master and slave units are randomly defined.



MEDALPOWER

Leave Power for Medal Power

www.medal-power.com

