



MEDALPOWER

INVERTER

4000W-24V
Low Frequency
Solar Inverter
MPI-4000W#24VPVT



www.medal-power.com

TABLE OF CONTENT

| | | |
|----|--------------------------|----|
| 1. | Safety Instructions..... | 1 |
| 2. | Description..... | 3 |
| 3. | Operation..... | 7 |
| 4. | Installation..... | 13 |
| 5. | Troubleshooting | 19 |
| 6. | Technical Data..... | 20 |
| 7. | Warranty Scope..... | 23 |
| | Appendix | 24 |

1. SAFETY INSTRUCTIONS

1.1 General

Please read the manual and all the safety remarks. This product is designed and tested in accordance with international standards. It must be used exclusively for the purpose for which it was designed.

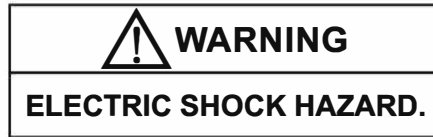

This product is worked with the rechargeable battery. It may still has dangerously voltage in input / output terminals. Please switch the AC and battery power source before carrying out maintenance or servicing the product.

Please call service center. Do not operate the product if any fault. Only Qualified person can undertake all servicing.

Never use the product where there is a risk of gas or dust explosions. (before using) Consult the battery manufacture's to confirm the products if can be used with the battery. Always comply with the battery manufacturer's safety instructions.

1.2 Installation

Read the installation instructions on the manual before installing. This is a Safety Class I product (supplied with a protective grounding terminal) . Uninterruptible protective grounding must be provided at the AC input and output terminals.

It will cause electric shock when the grounding protection has been faulty, please turn off the product.

Ensure that the DC and AC Input cables are fuse and the circuit breakers. Never replace the component with different type. Always consult the manual to determine the correct component.

Before connect AC, ensure the power source match to the manual requirement.

Never operate the product in a wet or dusty environment.

Ensure there is adequate free space for ventilation around the product and check that the ventilation vents are not blocked.

Ensure that the application's power consumption not exceed the product's maximum power.

1. 3 Transport and Storage

Ensure that the mains power and battery leads have been disconnected before storing or transporting the product.

No liability can be accepted for any transport damage if the equipment is shipped in non-original packaging.

Store the product in a dry environment, the storage temperature must be between -20°C and 60°C .

Consult the battery manufacturer's manual in respect of transport, storage, charging, recharging and disposal of the battery.

2. Description

Fig. 1 : Inverter

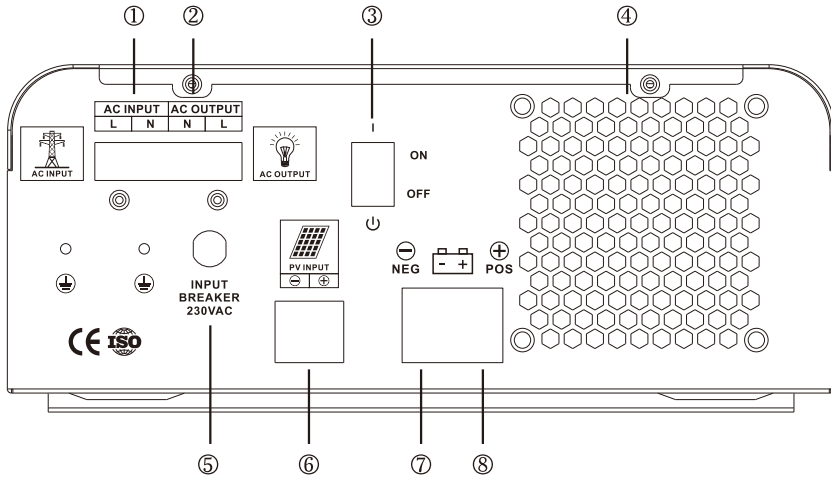

1KVA-2KVA

- ①.....AC input
- ②.....AC output
- ③.....Power on/off switch
- ④.....Fan
- ⑤.....Input breaker
- ⑥.....Solar panel input
- ⑦.....Battery terminal negative
- ⑧.....Battery terminal positive

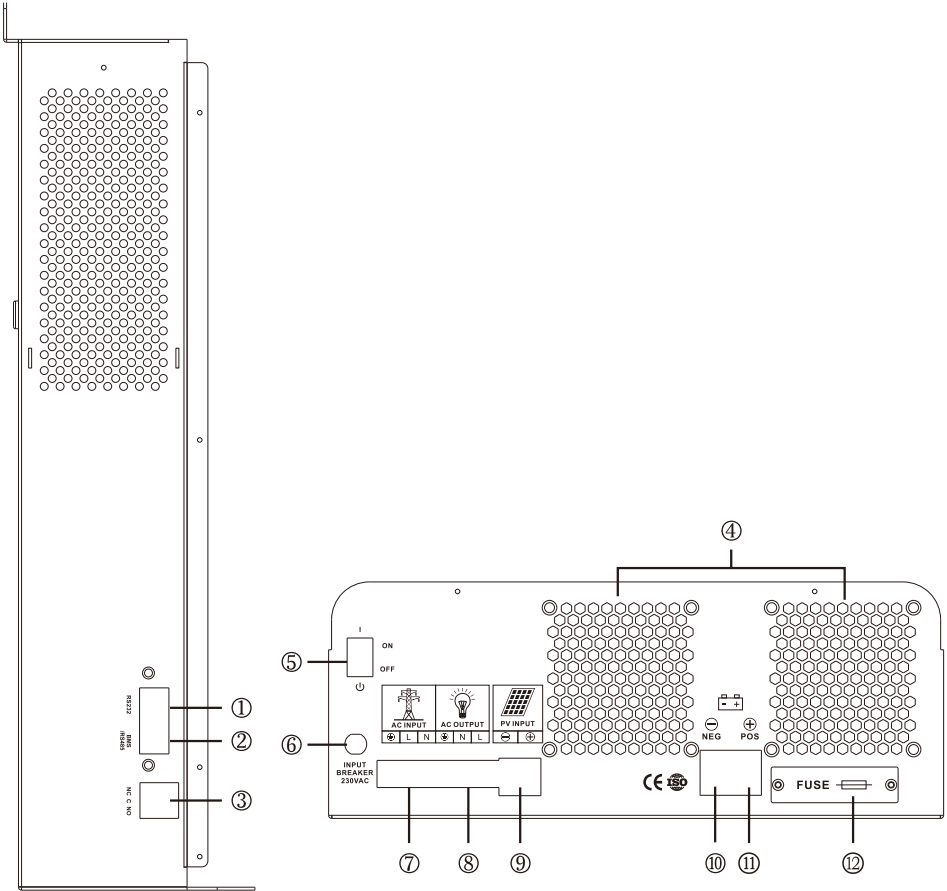

1KVA-5KVA

- | | |
|-----------------------------------|--|
| ①....RS232 communication port | ⑦....AC input |
| ②....BMS/RS485 communication port | ⑧....AC output |
| ③....Dry contact | ⑨....Solar panel input |
| ④....Fan | ⑩....Battery terminal negative |
| ⑤....Power on/off switch | ⑪....Battery terminal positive |
| ⑥....Input breaker | ⑫.... FUSE (located under the right fan) |

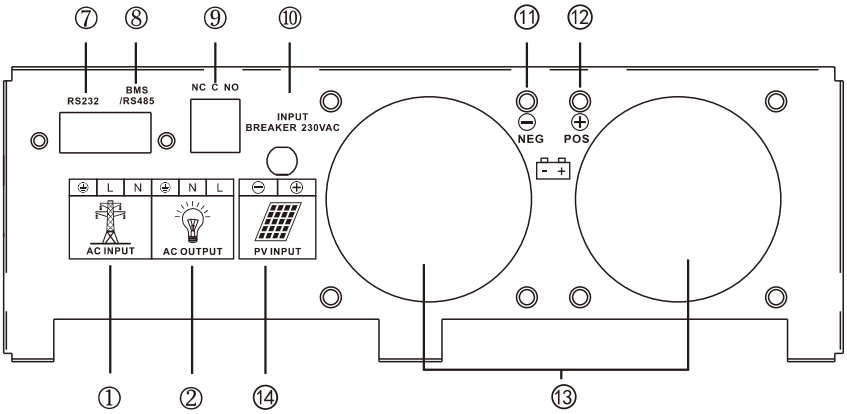
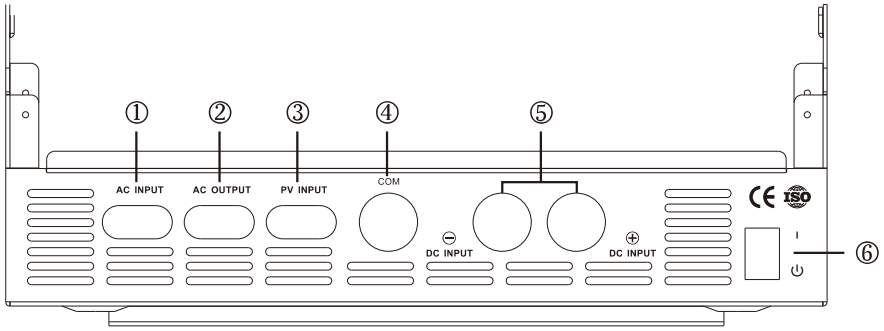

5024-6324

- | | |
|----------------------------|--------------------------------|
| 1.AC input | 8.BMS/RS485 communication port |
| 2.AC output | 9.Dry contact |
| 3.PV input | 10.Input breaker |
| 4.Communication port | 11.Battery terminal negative |
| 5.Battery input | 12.Battery terminal positive |
| 6.Power ON/OFF switch | 13.Fan |
| 7.RS232 communication port | 14.Solar panel input |

Fig 2 : LCD SCREEN

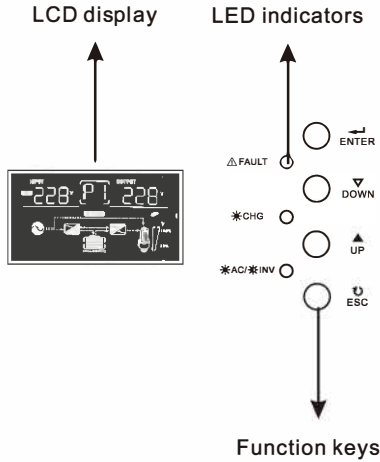

LED INDICATOR

| LED Indicator | | Messages | |
|---------------|--------|----------|---|
| ☀️ AC/☀️ INV | Green | Solid On | Output is powered by utility in Line mode. |
| | | Flashing | Output is powered by battery or PV in battery mode. |
| ☀️ CHG | Yellow | Solid On | Battery is fully charged. |
| | | Flashing | Battery is charging. |
| ⚠️ FAULT | Red | Solid On | The inverter is in the fault warning status. |

Function Keys

| Function Key | Description |
|--------------|--|
| ESC | To exit setting mode |
| UP | To go to previous selection |
| DOWN | To go to next selection |
| ENTER | To confirm the selection in setting mode or enter setting mode |

3. OPERATION

3.1 AC Mode

Switch on the power button, the product is fully functional, the green LED "AC In" will light up.

3.2 Inverter Mode

When electricity off or generator power being disconnected, it will transfer to inverter mode. The transfer time is less than 10 milliseconds so that computers and other electronic equipment will continue to operate without disruption. The green LED light of "Inverter" will light up.

3.3 Charging Mode

When electricity recovery or generator power on the green LED "AC In" comes up and the orange "Charge" light starts blinking. When the batteries are fully charged, the blinking orange light changes to Solid Orange.

3.4 Alarm Mode

When battery discharge and it gets close to the battery cutoff voltage, the red "Alarm" light starts showing with a continuous beeping sound, if the electricity not recovery, it will keep this status until the battery reaches the low voltage cut-off point and shut down automatically .

3.5 Bypass Mode

The product's power button is off. but the electricity or generator on, it has output to load meanwhile charging the battery. When the power button is off, if without electricity or generator off, there will be no output to load.

3.6 Saver Mode

If there is no supply of grid, the inverter's AC output will not be supplied until a load greater than 15 watts is connected to the inverter. It automatically detects the connected load every 25 seconds.

3.7 Setting Mode/Error Codes for reference

Enter setting mode, Press "ENTER" button for 10 seconds.

Exit setting mode, Press "ESC" button repeatedly.

1. Press "UP" or "DOWN" button to choose the parameter and then press "ENTER" button.

2. When parameter is flashing, press "UP" or "DOWN" to change it and then press "ENTER" button to confirm.

When setting: Setting icon is flashing

Setting succeed: Left-sided frame of the parameter will flash

Setting failed: FAULT light on

| Settings | Display (Left) | Display (Mid) | Display (Right) | Setting range | Descriptions |
|------------------------------|----------------|---------------|-----------------|---------------------|---|
| Mains input voltage range | Alr | 00 | UPS | Narrow range | Mains input range is 180-265V |
| | | | APL | Wide range | Mains input range is 155-265V |
| Mains frequency oltage range | AFr | 01 | LO | Narrow range | Mains input frequency range is 45-65HZ |
| | | | HI | Wide range | Mains input frequency range is 40-70HZ |
| Working mode | None | 02 | UTI | Mains priority | The utility power will provide power to the load first. Only when the utility power is not enough to supply the load, the solar energy And the battery will provide power to the load |
| | | | SOL | Solar priority | When solar energy is sufficient, solar energy will be preferentially provided to the load. When there is solar energy but not enough, the solar energy and battery power will provide power to the load at the same time. When there is no solar power, the utility will provide power to the load. At the same time, If the battery voltage drops to the low-battery warning voltage point or the set DC-to-AC voltage point, the mains will also provide power to the load. |
| | | | SBU | Battery priority | When solar energy is sufficient, solar energy will be preferentially provided to the load. When there is solar energy but not enough, the solar energy and battery power will provide power to the load at the same time. If the battery voltage drops to the low battery warning voltage point or the set DC to AC voltage point, the mains will provide power to the load. |
| Charging mode | None | 03 | CUT | Mains priority | The energy of the mains and the solar energy charge the battery at the same time |
| | | | CSO | Solar priority | In the solar priority mode, when the PV meets the requirements, the battery is charged with solar energy preferentially, and when the battery voltage is too low, the mains charge will be started |
| | | | OSO | Solar charging only | The machine simply uses the energy of solar energy to charge the battery |
| Mains charging current ratio | ACP | 04 | 100% | 10~100% | Adjustable charging current ratio of mains |
| Solar charging current ratio | SCP | 05 | 100% | 20-100% | You can adjust the charging current proportional solar |

| Settings | Display (Left) | Display (Mid) | Display (Right) | Setting range | Descriptions |
|------------------------------------|----------------|---------------|-----------------|---------------|--|
| Boost charging voltage | CU | 06 | 14.2V | 13.5~15.0V | Bulk charging voltage setting, according to different types of batteries |
| | | | 28.4V | 27.0~30.0V | |
| | | | 56.8V | 54.0~60.0V | |
| Float charging voltage | FLU | 07 | 13.6V | 12.5~14.0V | Float voltage setting, according to different types of batteries |
| | | | 27.2V | 25.0~28.0V | |
| | | | 54.4V | 50.0~56.0V | |
| Battery lockdown voltage | COU | 08 | 10.2V | 9.5~11.5V | Set the shutdown voltage point of battery protection voltage |
| | | | 20.4V | 19.0~23.0V | |
| | | | 40.8V | 38.0~46.0V | |
| Charging voltage of mains recovery | DTA | 09 | 12.0V | 11.5~12.5V | Set the battery voltage point when the mains power is involved in the solar energy priority charging mode |
| | | | 24.0V | 23.0~25.0V | |
| | | | 48.0V | 46.0~50.0V | |
| Charging voltage of mains off | ATD | 10 | 13.5V | 13.0~14.0V | Select the voltage point of converting from mains to solar power in solar priority mode |
| | | | 27.0V | 26.0~28.0V | |
| | | | 54.0V | 52.0~56.0V | |
| Inv. output voltage | OU | 11 | 220V | 200~240V | Set the inverter output voltage |
| Mains detection speed | CST | 12 | HI | High speed | Mains sensitivity settings: high medium low |
| | | | IDE | Mid. speed | |
| | | | LO | Low speed | |
| Inv. output frequency | OF | 13 | 50Hz | | Set inverter output frequency |
| | | | 60Hz | | |
| Fault restart switch | RA | 14 | TE | On | Restart 3 times after short circuit or overload |
| | | | TD | Off | No restart after short circuit or overload |
| Backlight control | BLC | 15 | LON | Always on | The display backlight is always on |
| | | | LOF | Always off | The display backlight is always off |
| | | | LOD | Delay off | Display backlight smart switch |
| Buzzer control switch | BEC | 16 | AON | On | Allows beeping in fault state |
| | | | AOF | Off | No beeping in any state |
| Low battery alarm switch | BOL | 17 | OFF | Off | Intelligent battery protection function, it is not recommended to change |
| | | | ON | On | |
| Load limit | LL | 18 | OFF | Off | Intelligent transformer temperature protection function, it is not recommended to change |
| | | | ON | On | |
| Load alarm limit | LEL | 19 | OFF | Off | This setting does not adapt to this inverter. Setting not available. |
| | | | ON | On | |
| Baud rate | BAU | 20 | 0 | 2400 | Set the communication baud rate |
| | | | 1 | 4800 | |
| | | | 2 | 9600 | |
| Output display mode | ODT | 21 | 220V | 220V | Set display output voltage |
| | | | 110V | 110V | |
| Swon bat voltage | BLS | 22 | 11.5V | 10.5~12.2V | After the machine is shut down abnormally, the battery voltage must be higher than the set value before it can be turned on normally |
| | | | 23.0V | 21~24.4V | |
| | | | 46.0V | 42~48.8V | |

| Settings | Display (Left) | Display (Mid) | Display (Right) | Setting range | Descriptions |
|-------------------------|----------------|---------------|-----------------|---------------|---|
| Bat low off restart vol | BRU | 23 | 13.0V | 12.0~14.0V | After the machine is powered off at low power, the battery voltage is higher than the set value and it can be automatically turned on. |
| | | | 26.0V | 24.0~28.0V | |
| | | | 52.0V | 48.0~56.0V | |
| Battery type | BTT | 24 | SEL | SEL | Sealed Lead Acid Battery |
| | | | GEL | GEL | Gel Battery |
| | | | FLD | FLD | Inter Cell |
| | | | USER | USER | Customer Customization |
| | | | TER | LiCoMnNi02 | Ternary Lithium Battery |
| | | | LIF | BAT-LiFePO4 | Lithium Iron Phosphate Battery |
| BMS Function Switch | BnS | 25 | OFF | On Off | Whether to enable the BMS communication function |
| Bat Soc Under Lock | BSU | 26 | 10% | 5~50% | BMS low voltage SOC value, if the BMS SOC value is lower than the set value, the inverter will shut down to protect the battery |
| Bat Soc Turn To Ac | STG | 27 | 20% | 5~50% | When the working mode of the inverter is set to the battery priority mode, the inverter will be forced to enter the mains charging when the SOC of the BMS is lower than the set value. |
| Bat Soc Turn To Dc | STB | 28 | 95% | 50~100% | When the working mode of the inverter is set to the battery priority mode, the inverter resumes the DC working mode when the SOC of the BMS is higher than the set value. |
| Bat Restart Soc | BSR | 29 | 50% | 30~100% | When the inverter is turned on, the SOC must be higher than the set value to work normally. |
| Factory Reset | RS | None | OFF | On | All settings are restored to factory settings |
| | | | | Off | No recovery process, keep existing settings |
| ECO Mode | ECO | None | OFF | On | ECO mode switching |
| | | | | Off | |

When the BMS/485 communication interface is externally connected, as shown in the following figure:

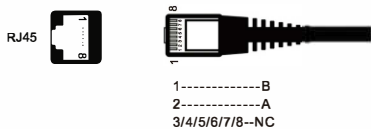

Communication Connection

Please use supplied communication cable to connect to inverter and PC. Please install a monitoring software on the computer.

Dry Contact Signal

There is one dry contact (3A/250VAC) available on the rear panel. It could be used to deliver signal to external device when battery voltage reaches warning level.

| Unit Status | Condition | | Dry contact port:  | | |
|-------------|--|------------------|--|--------|-------|
| | | | NC & C | NO & C | |
| Power Off | Unit is off and no output is powered. | | Close | Open | |
| Power On | Output is powered from battery or solar. | Normal mode | Battery voltage < Low DC warning voltage | Open | Close |
| | | | Battery voltage > Float charging voltage | Close | Open |
| | | Solar first mode | Battery voltage < Solar to AC voltage | Open | Close |
| | | | Battery voltage > AC to DC voltage | Close | Open |

Error Codes for reference

| Display (Left) | Display (Right) | Details |
|----------------|-----------------|---|
| ALA | 021 | Inverter communication connection failure alarm |
| ALA | 233 | Abnormal mains output alarm |
| ALA | 236 | Abnormal machine load alarm |
| ALA | 237 | Inverter overload alarm |
| ALA | 231 | Abnormal output alarm |
| ALA | 234 | High battery voltage alarm |
| ALA | 235 | Low battery voltage alarm |
| ALA | 241 | Memory chip read and write error alarm |
| ALA | 232 | Memory chip connection failure alarm |
| ALA | 238 | Inverter over temperature alarm |
| ALA | 239 | Load-causing over temperature alarm |
| ALA | 242 | Host computer software planned shutdown alarm |
| ALA | 244 | BMS other faults |

| | | |
|-----|-----|---|
| ALA | 245 | BMS communication abnormal |
| ALA | 246 | BMS charging overcurrent |
| ALA | 247 | BMS discharge overcurrent |
| ALA | 248 | BMS High Temperature |
| ALA | 249 | BMS Low Temperature |
| FAL | 102 | Inverter overload shutdown fault |
| FAL | 104 | Abnormal output fault |
| FAL | 105 | Abnormal load fault |
| FAL | 106 | Inverter over temperature fault |
| FAL | 135 | High battery voltage fault |
| FAL | 134 | Low battery voltage fault |
| FAL | 123 | Load-causing over temperature fault |
| FAL | 169 | Current detection signal failure |
| FAL | 161 | Abnormal mains output fault |
| FAL | 152 | Temperature sensor connection failure |
| FAL | 162 | Host computer software planned shutdown failure |

4. INSTALLATION

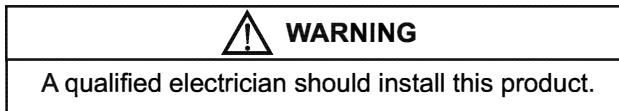

4. 1 Locating and Mounting the Inverter

The product must be installed in a dry and well-ventilated area, as close as possible to the batteries. There should be a clear space of at least 10cm for cooling.

High temperature will result following issue:

- Reduced product serving life.
- Reduced charging current.
- Reduced peak capacity, or shutdown of the inverter.

Never mount the appliance directly above the batteries. The product is suitable for wall mounting. The appliance can be mounted horizontally as well as vertically; vertical mounting is preferable. The vertical position offers optimum cooling.

After installation, keeping the air circulating inside the product. In order to minimize the losses of cable voltage, keep the suitable distance between the product and battery.

For safety purposes this product should be installed in a well ventilated place, keep it away from chemicals synthetic components curtains or other textiles, etc.

4. 2 AC Wiring

This is a Safety Class I product (supplied with a protective grounding terminal). Uninterruptible protective grounding must be provided at the AC input and/output terminals.

AC Wiring should be connected with following order:

- AC INPUT (Source)
- AC OUTPUT (Load)



Fig 3:AC input/Output Connections

AC Input: The product has Input protection circuit breaker. This should be switched off before the wiring connection.

Remove the AC wiring compartment cover to connect AC terminal, include grounding L and N to the corresponding terminal.

AC Output: The product has output protection circuit breaker. It should be switched off before the wiring connection. When connect the AC OUTPUT wiring, it should be connected the corresponding terminal.

After wiring ,double check and review all connections to make sure the wires are in the correct terminals and the terminals are tight.

AC Safety Grounding: During the AC wiring installation, AC input and output ground wires are connected to the product. The AC input ground wire must connect to the incoming ground from your AC utility source. The AC output ground wire should go to the grounding point for your applications.

4.3 DC Wiring:

| |
|--|
|  WARNING |
| <p>DO NOT connect the DC wires from the battery bank to the inverter until:</p> <ul style="list-style-type: none">● All AC wiring is complete,● The correct DC and AC protection switches are OFF● The correct DC voltage and polarity have been verified |

Depending upon the type of batteries you use in the installation (6 or 12VDC), the batteries must be wired in series, parallel, or series-parallel. The interconnecting DC wires must be sized and rated exactly the same as those used between the battery bank and the products.

To ensure the best performance from your inverter system, do not use old or untested batteries. Batteries should be of the same size, type, rating and age.

4.3.1 Procedure

The battery's Ampere Hour bigger, the back up time longer, and the battery connects wire should be corresponding.

Please follow below connect the battery cables:

| |
|---|
|  WARNING |
| <ul style="list-style-type: none">● Use an insulated box spanner in order to avoid shorting the battery.● Avoid shorting the battery cables. |

Connect the battery cables: the + (red) on the left and the-(black) on the right,to the battery. Reverse polarity connection (+ to - and - to +) will cause damage to the product.(Safety fuse inside the Inverter unit can be damaged)

The DC over current device (i.e.,fuse or circuit breaker) must be placed in the positive (RED) DC cable line between the inverter's positive DC terminal and the battery's positive terminal (RED);as close to the battery as possible.

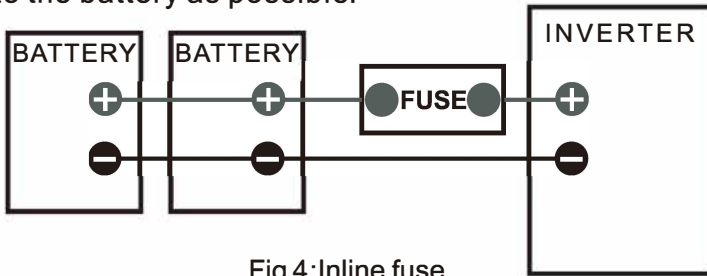

Fig 4:Inline fuse

A brief spark or arc may occur when connecting the battery cables to the inverter DC terminals;this is normal and due to the inverter's internal capacitors being charged.

All wiring to the battery terminals should be checked periodically (once a month) for proper tightening

Secure the nuts tightly in order to reduce the contact resistance as much as possible.

Be aware that over-tightening or misthreading the nuts on the DC terminals can cause the bolts to strip and snap/break off.

4.3.2 DC Wiring Size

It is important to use the correct sized DC wire to achieve maximum efficiency from the system and to reduce fire hazards associated with overheating. Always keep your wire runs as short as practical to prevent low voltage shutdowns and to keep the DC breaker from nuisance tripping (or open fuses) because of increased current draw. The correct minimum DC wire size (and corresponding over current device) is required in order to reduce stress on the inverter minimize voltage drops.increase system efficiency and ensure the inverter's ability to surge heavy loads. If the distance from the inverter to the battery bank is <5 feet.use a minimum DC wire size of #2 AWG (33.6 mm²).If the distance between the inverter and the battery is >5 feet.the DC wire will need to be increased.Longer distances cause an increase in resistance.which affects the performance of the inverter.

Tab.I

| Models | Minimum DC Wire Size(rating) | Maximum DC Fuse size | DC Grounding wire size |
|--------|------------------------------|----------------------|------------------------|
| 800 | 16/8mm ² | 100/50A | 2.5mm ² |
| 1200 | 25/16mm ² | 160/80A | 2.5mm ² |
| 1600 | 32/16mm ² | 200/100A | 2.5mm ² |
| 2400 | 25/16mm ² | 150/80A | 2.5mm ² |
| 3000 | 32/16mm ² | 200/100A | 2.5mm ² |
| 4000 | 50/25mm ² | 250/160A | 2.5mm ² |

4.3.3 Parallel and Series Connection

12 Volts Battery In Parallel

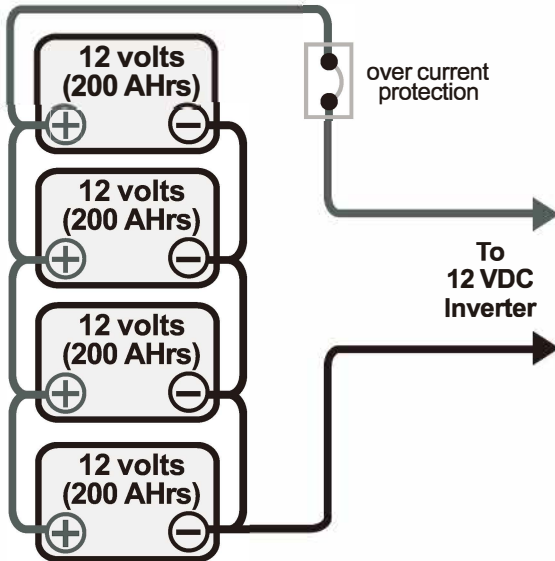

12 volt battery (total capacity=800 Ah)

Fig 5. Parallel Battery Wiring

12 volts Battery in Series

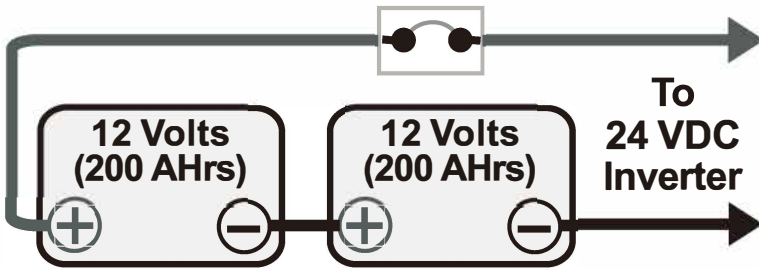

24 Volts battery (total capacity=200 Ah)

Fig 6. Parallel Battery Wiring

Difference between Series and Parallel connection

Batteries in Parallel

Voltage remain the same
Ah capacity doubles

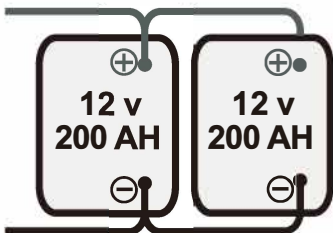

System Voltage = 12Volts
Ah Capacity = 400AH

Batteries in Series

Voltage doubles
Ah capacity stays the same

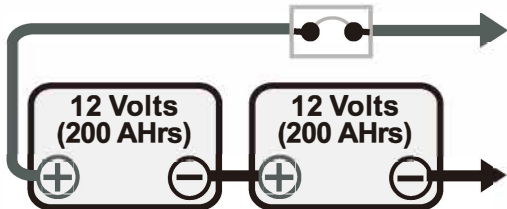

System Voltage=24V
Ah Capacity=200AH

5. TROUBLESHOOTING

Proceed as follows for quick detection of common faults. DC loads must be disconnected from the batteries and the AC loads must be disconnected from the inverter before the inverter and/or battery charger is tested.

Consult your local dealer/repair center if the fault cannot be resolved.

Note: If the fuse is burnt due to the reverse connection of the battery or overcurrent, please remove the right fan and replace the fuse. Please make sure the power supply of the machine is completely disconnected before replacing.

Tab.III

| Problem | Cause | Solution |
|--|---------------------------------|--|
| The inverter fails to operate when switched on | Battery terminal not firm | Tighten the battery terminals. |
| Continuous spark from the inverter terminal | Battery terminal reversal | Check and connect the cable to the right terminal lead. |
| No output from inverter | Output cable terminals loosed | Open the casing and connect the output cable terminals firm to the appropriate lead. |
| Inverter not charging battery | input power less than(<) 150VAC | A step-up stabilizer of rating higher than the inverter should be installed. |
| Continuous alarm when the inverter is loaded | Overloading condition | Check the loads and disconnect heavier loads. |

6. TECHNICAL DATASHEET(1-6.3K)

| MODEL | 800 | 1200 | 1600 | 2400 | 3000 | 4000 |
|----------------------------------|---|---------|--------|--------|--------|--------|
| Input | | | | | | |
| Capacity (VA) | 1000VA | 1 500VA | 2000VA | 3000VA | 3800VA | 5000VA |
| Voltage (DC) | 12V | 12V | 24V | 24V | 24V | 24V |
| Nominal Voltage | 220VAC/110VAC | | | | | |
| Voltage Range | 154-265VAC/77-135VAC | | | | | |
| Frequency | 50-60Hz Auto sensing | | | | | |
| Output | | | | | | |
| Watt | 800W | 1200W | 1600W | 2400W | 3000W | 4000W |
| Voltage | 220VAC/110VAC(± 10% ups mode) | | | | | |
| Frequency | 50/60Hz | | | | | |
| Waveform | Pure sinewave | | | | | |
| Transfer time(AC to DC) | <8ms | | | | | |
| Transfer time(DC to AC) | <8ms | | | | | |
| Output voltage regulation | 10%rms | | | | | |
| Bypass Mode | Yes | | | | | |
| Saver Mode | Yes | | | | | |
| Efficiency | >98% | | | | | |
| Protection | | | | | | |
| Input Protection | Circuit Breaker | | | | | |
| Output Protection | Circuit Breaker | | | | | |
| Battery | | | | | | |
| Battery Type | AGM-Deep Cycle,GEL,LIFEPO4 | | | | | |
| | Up to 500Ah | | | | | |
| Charging current | 20/10A | 30/15A | 35/18A | 30/15A | 35/18A | 40/20A |
| Low Level disconnect(Selectable) | 12V:(10V or 10.5V) 24V:(20V or 21V) 48V:(40V or 42V) | | | | | |
| LCD Indicator status | Input AC,Output AC | | | | | |
| | Battery DC,Output Load | | | | | |
| | Alarm,Fault | | | | | |
| | Battery Charge Level | | | | | |
| LED Indicator status | Output Frequency | | | | | |
| | AC Line In:Green | | | | | |
| | Inverter:Green | | | | | |
| | Charging:Yellow | | | | | |
| Battery low alarm | Alarm:Red | | | | | |
| | 12V: battery light discharge 11.5V ; battery load discharge 11.5V@load<20% ; 11V@load>50%/10.5V@load>50% ; 24V: battery light discharge 23V ; battery load discharge 23V@load<20% ; 22V@load>50%/21V@load>50% ; 48V: battery light discharge 46V ; battery load discharge 46V@load<20% ; 44V@load>50%/42V@load>50% ; | | | | | |
| Battery low recovery | 12V: battery light discharge 12V ; battery load discharge 12V@load<20% ; 11.5V@load>50%/11V@load>50% ; 24V: battery light discharge 24V ; battery load discharge 24V@load<20% ; 23V@load>50%/22V@load>50% ; 48V: battery light discharge 48V ; battery load discharge 48V@load<20% ; 46V@load>50%/44V@load>50% ; | | | | | |
| | 12V: battery light discharge 11V ; battery load discharge 11V@load<20% ; 10.5V@load>50%/10V@load>50% ; 24V: battery light discharge 22V ; battery load discharge 22V@load<20% ; 21V@load>50%/20V@load>50% ; 48V: battery light discharge 44V ; battery load discharge 44V@load<20% ; 42V@load>50%/40V@load>50% ; | | | | | |
| DC low voltage shutdown | 12V: battery light discharge 11V ; battery load discharge 11V@load<20% ; 10.5V@load>50%/10V@load>50% ; 24V: battery light discharge 22V ; battery load discharge 22V@load<20% ; 21V@load>50%/20V@load>50% ; 48V: battery light discharge 44V ; battery load discharge 44V@load<20% ; 42V@load>50%/40V@load>50% ; | | | | | |
| DC high voltage alarm and fault | 16V/32V | | | | | |
| DC high voltage recovery | 15V/30V | | | | | |

| | |
|---------------------------------------|--|
| Maximum PV array power | 12V:800W 24V:1600W 48V:3200W |
| MPPT/PWM input voltage range | 12V:MPPT15-150VDC(or PWM15VDC-50VDC) 24V:MPPT30-150VDC(or PWM30VDC-105VDC) 48V:MPPT60-150VDC(or PWM60VDC-105VDC) |
| Maximum PV array open circuit voltage | 12V:MPPT150VDC(or PWM50VDC) 24V:MPPT150VDC(or PWM105VDC) 48V:MPPT150VDC(or PWM105VDC) |
| Maximum solar charging current | 60A |
| Alarm | |
| Low battery alarm | Audible alarm-1 beeping per second |
| Overload alarm | Audible alarm-continuous beeping |
| Fault | Audible alarm-continuous beeping |
| Environment | |
| Temperature | -10~50°C |
| Humidity | C0-95 %, Non condensing |
| Accoustic Noise(db) | <45dB |

7. Warranty Scope

The following is not within the scope of warranty:

- (a) Battery configured by user.
- (b) Operate not according to the user's manual, resulting in damage to the machine.
- (c) Mechanical damage due to natural disasters such as fire, flood, etc..
- (d) Products beyond the warranty period, provide the paid maintenance service.

Appendix

How to choose and configure PV panels

The following parameters can be found in the specifications of each PV panel:

- Pmax: Maximum output power (W)
- Voc: Open circuit voltage (V)
- Isc: Short circuit current (A)
- Vpm: Rated voltage (V)
- Ipm: Rated current (A)

PV panels can be connected in series or in parallel to obtain the required output voltage and current to meet the allowable range of the solar controller.

When connecting PV panels in series, the total maximum voltage and current are:

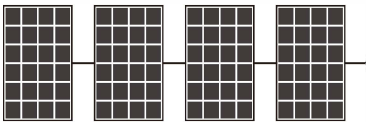

$$V_{string} = V_1 + V_2 + V_3 + V_4 \dots$$

$$I_{string} = I_1 = I_2 = I_3 = I_4 \dots$$

When the PV panels that have been connected in series are connected in parallel, the total maximum voltage and current are:

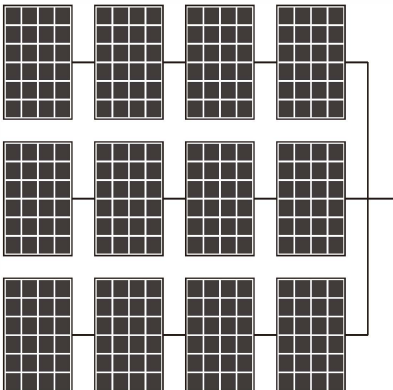

$$V_{total} = V_{string1} = V_{string2} = V_{string3} = V_{string4} \dots$$

$$I_{total} = I_{string1} + I_{string2} + I_{string3} + I_{string4} \dots$$

- In either case, the total output power is the power of a single PV panel \times the total number of PV panels. The criteria for configuring PV panels is that the total power should be equal to or slightly greater than the maximum allowable PV power of the solar controller (please refer to the technical parameter table). The excess capacity of PV panels does not contribute to the capacity of solar chargers and will only lead to higher installation costs.
- The total I_{pm} of the PV panels should be less than the maximum charging current of the inverter (60A) .
- The total V_{oc} of the PV panel should be less than the maximum PV input voltage of the inverter (please refer to the technical parameter table).

Example 1: Take a 12 V inverter as an example to select suitable PV modules. Considering that the total V_{oc} of the PV panel cannot exceed the maximum (PWM controller 30 V / MPPT controller 60 V). The total power should be equal to or slightly greater than 800 W, we can choose the following specifications of PV panels.

| | | |
|-----------------------------------|-------|---|
| Maximum power (P_{max}) | 80W | The number of PV panels connected in series for each group: PWM→1 PCS ($1 \times 21.6V < 30V$) MPPT→2 PCS ($2 \times 21.6V < 60V$) Total number of PV panels: $10PCS \rightarrow 800W/80W=10$ (PCS) Number of groups that can be connected in parallel: PWM→10groups ($10/1 = 10$ groups) MPPT →5 groups ($10/2 = 5$ groups) |
| Rated voltage $V_{pm}(V)$ | 18V | |
| Rated current $I_{pm}(A)$ | 4.46A | |
| Open circuit voltage $V_{oc}(V)$ | 21.6V | |
| Short circuit current $I_{sc}(A)$ | 4.8A | |

The configuration scheme of the 12 V inverter is:

PWM controller: 10 PV panels are connected in parallel to the inverter.

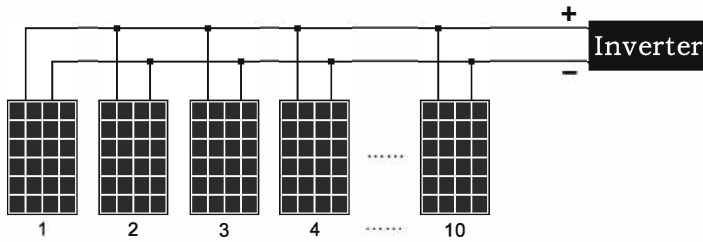

MPPT controller: Every 2 PV panels are connected in series to form a group, and connected to 5 groups of PV panels (also can be connected same as PWM).

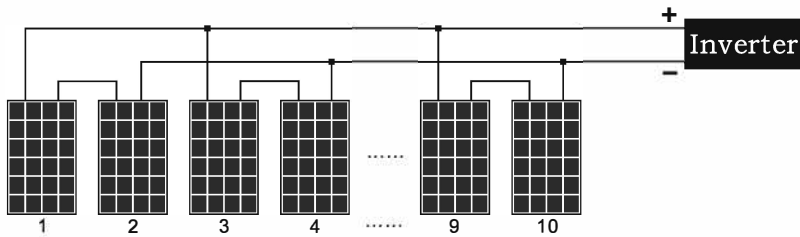

Example 2: Take a 24 V inverter as an example to select suitable PV modules. Consider that the maximum total Voc of PV panels cannot exceed (PWM controller 60 V / MPPT controller 60 V) . The total power should be equal to or slightly greater than 1600 W, we can choose the following specifications of PV panels.

| | | |
|------------------------------|-------|--|
| Maximum power (Pmax) | 80W | The number of PV panels connected in series for each group: PWM→2 PCS (2*21.6V<60V) MPPT→2 PCS (2*21.6V<60V) |
| Rated voltage Vpm(V) | 18V | |
| Rated current Ipm(A) | 4.46A | Total number of PV panels: 20PCS→1600W/80W=20 (PCS) |
| Open circuit voltage Voc(V) | 21.6V | Number of groups that can be connected in parallel: |
| Short circuit current Isc(A) | 4.8A | PWM→10groups (20/2 = 10 groups) MPPT →10 groups (20/2 = 10 groups) |

The configuration scheme of the 24V inverter is:

PWM controller: every 2 PV panels are connected in series into one group, and 10 groups of PV panels are connected.

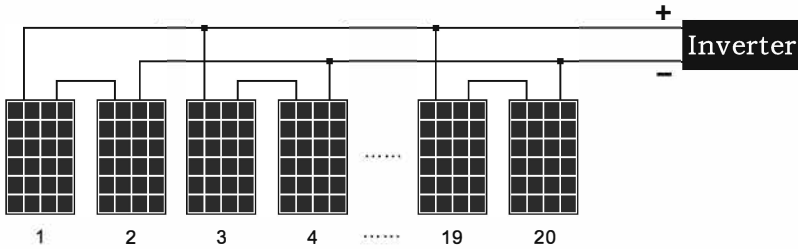

MPPT controller: Every 2 PV panels are connected in series into one group, and 10 groups of PV panels are connected.

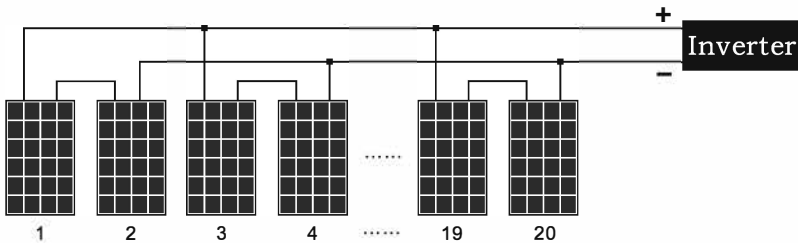

Example 3: Take the 48 V inverter as an example to select the appropriate PV module. Consider that the total V_{oc} of the PV panel cannot exceed the maximum (PWM controller 105 V / MPPT controller 150 V). The total power should be equal to or slightly greater than 3200 W , we can choose the following specifications of PV panels.

| | | |
|-----------------------------------|-------|--|
| Maximum power (Pmax) | 80W | The number of PV panels connected in series for each group: PWM→4 PCS (4*21.6V<105V) MPPT→6 PCS (6*21.6V<150V) Total number of PV panels: 40PCS→3200W/80W=40 (PCS) Number of groups that can be connected in parallel: PWM→10groups (40/4 = 10 groups) MPPT →7 groups (40/6 = 7 groups) |
| Rated voltage $V_{pm}(V)$ | 18V | |
| Rated current $I_{pm}(A)$ | 4.46A | |
| Open circuit voltage $V_{oc}(V)$ | 21.6V | |
| Short circuit current $I_{sc}(A)$ | 4.8A | |

The configuration scheme of the 48V inverter is:

PWM controller: Every 4 PV panels are connected in series into one group, and 10 groups of PV panels are connected .

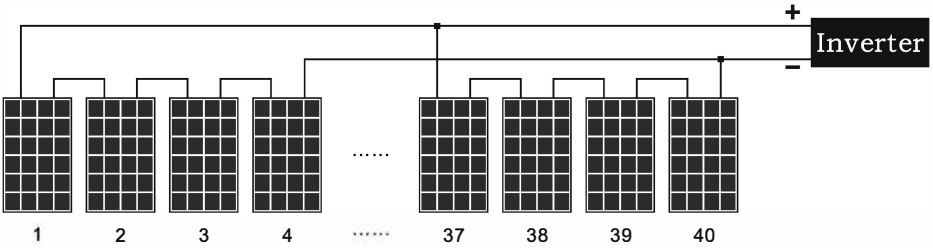

MPPT controller: Every 6 PV panels are connected in series into one group, and 7 groups of PV panels are connected (it can be connected same as PWM).

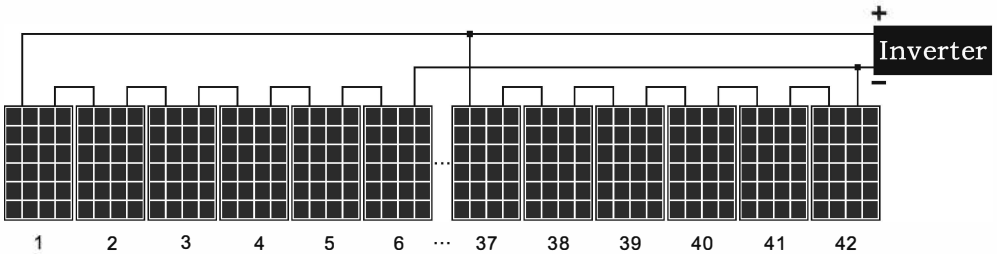

● **Daily power generation of solar panels:**

Power generation = total solar panel power × controller conversion efficiency × local sunshine average time



MEDALPOWER

Leave Power for Medal Power

www.medal-power.com

